

Lecture 6

House Allocation and Kidney Exchange

Aug 18, 2023

|

Rohit Vaish

Housing Market

[Shapley and Scarf, *JME* 1974]

Housing Market

[Shapley and Scarf, *JME* 1974]



Housing Market

[Shapley and Scarf, *JME* 1974]



Housing Market

[Shapley and Scarf, *JME* 1974]

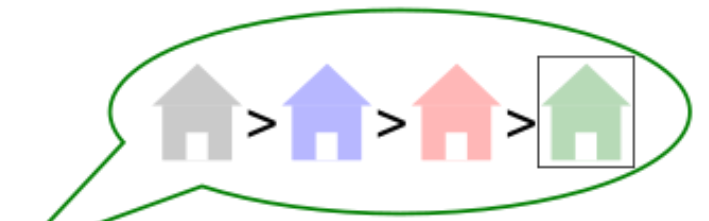
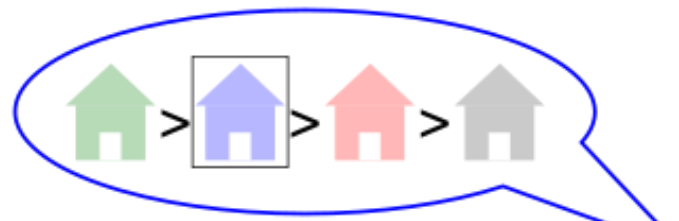
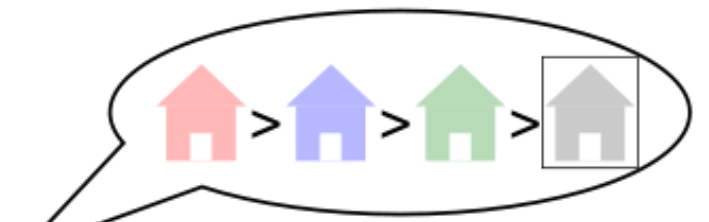
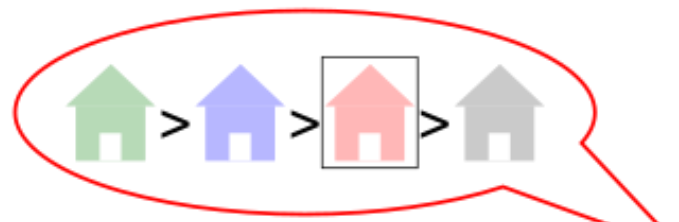

Housing Market

[Shapley and Scarf, *JME* 1974]

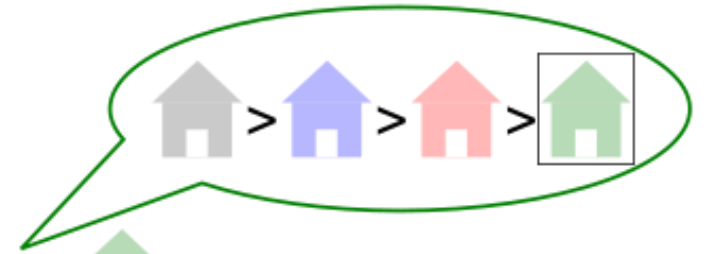
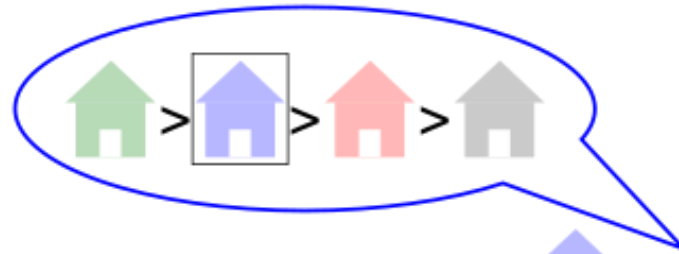
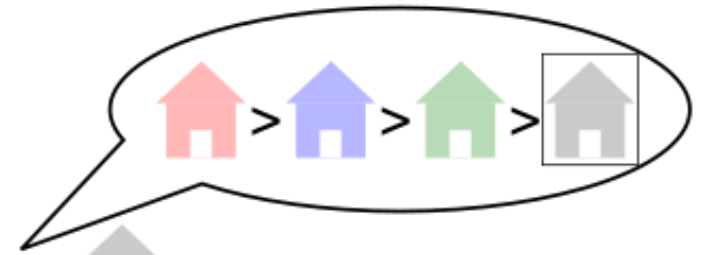
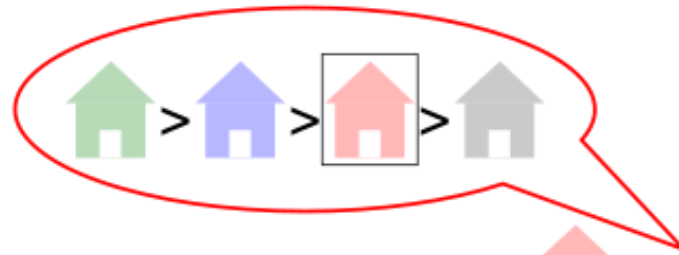

Can't use money. Only way to make agents happier is via *exchanges*.

Housing Market

[Shapley and Scarf, *JME* 1974]

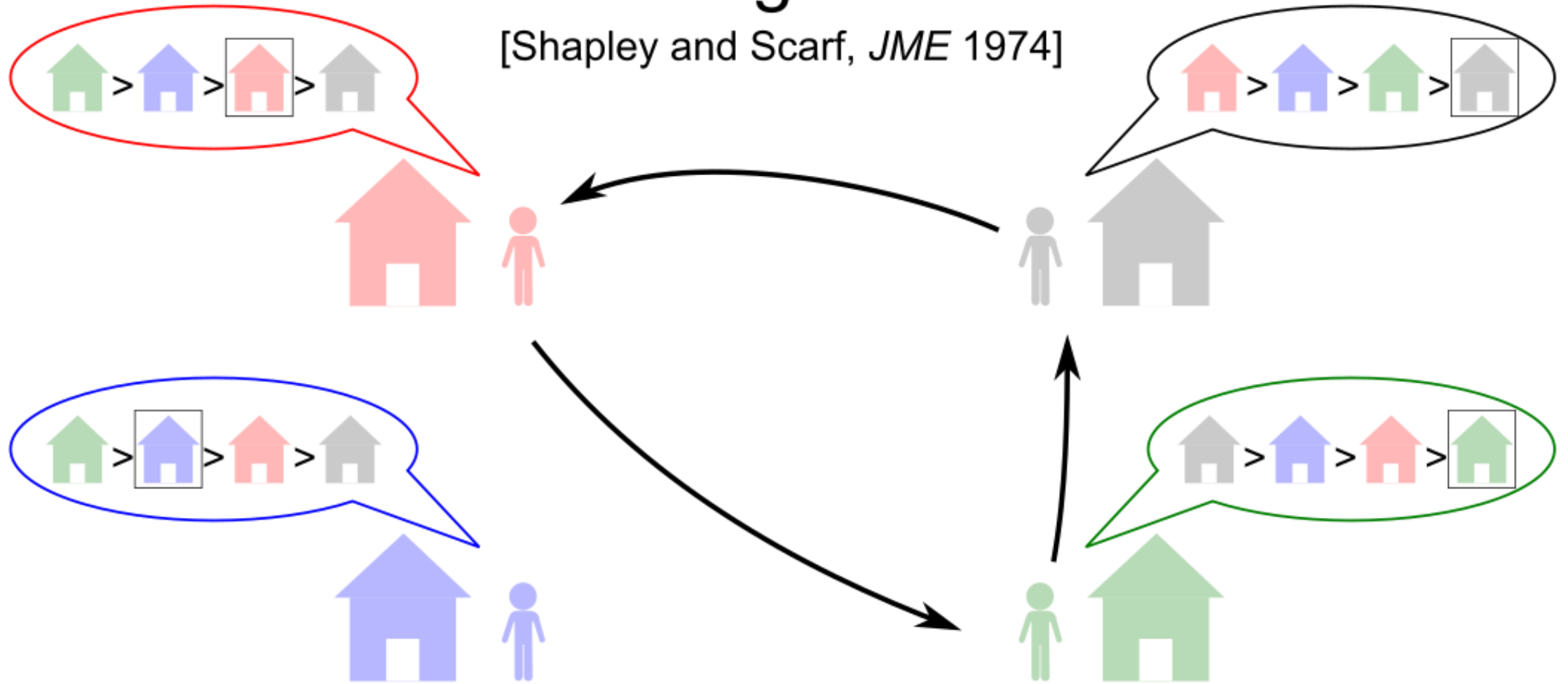

Can't use money. Only way to make agents happier is via *exchanges*.

Housing Market

[Shapley and Scarf, *JME* 1974]

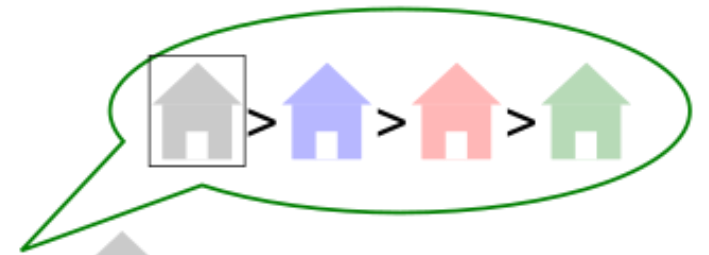
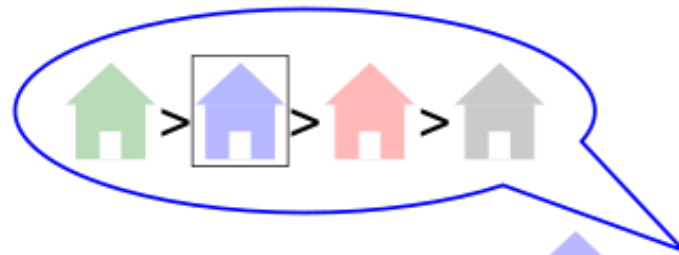
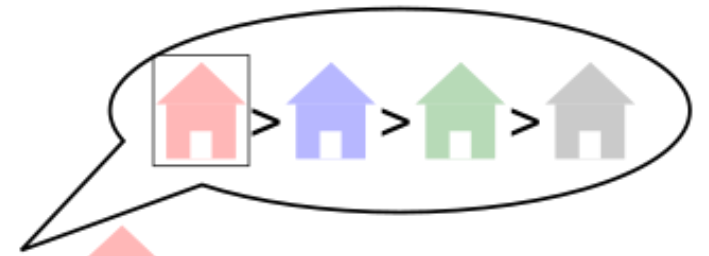
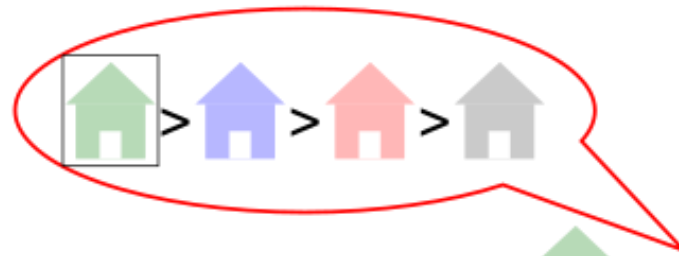

Can't use money. Only way to make agents happier is via *exchanges*.

Housing Market

[Shapley and Scarf, *JME* 1974]

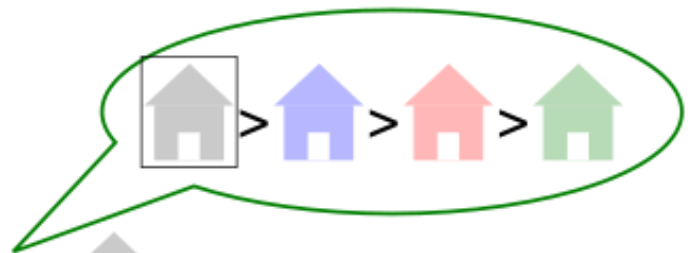
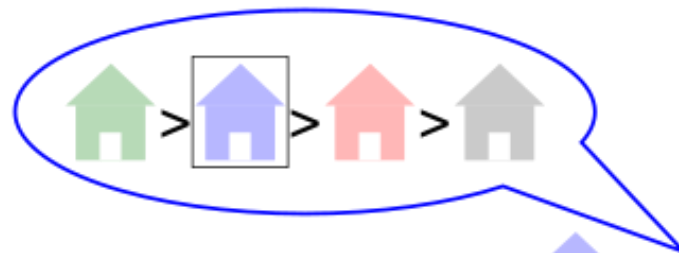
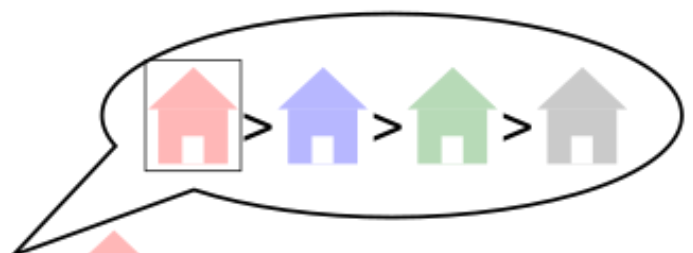
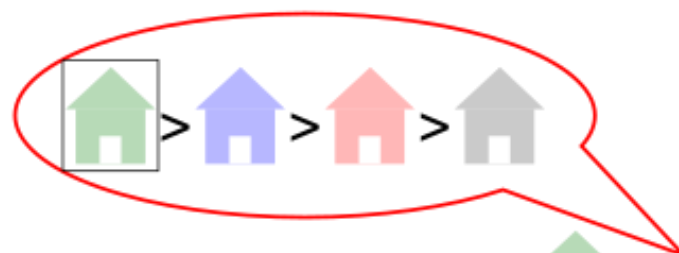

Is there a way to exchange houses to make the agents "maximally happy"?

Top-Trading Cycle Algorithm (TTCA)

[Shapley and Scarf, *JME* 1974 (attributed to David Gale)]

Top-Trading Cycle Algorithm (TTCA)

[Shapley and Scarf, *JME* 1974 (attributed to David Gale)]

While there is a remaining agent:

- Each remaining agent points to the owner of its favorite house.
- There must be a cycle (include self-loops). Do the cyclic exchange.
- Remove the agents and houses involved in the above exchange.

Top-Trading Cycle Algorithm (TTCA)

[Shapley and Scarf, *JME* 1974 (attributed to David Gale)]

While there is a remaining agent:

- Each remaining agent points to the owner of its favorite house.
- There must be a cycle (include self-loops). Do the cyclic exchange.
- Remove the agents and houses involved in the above exchange.

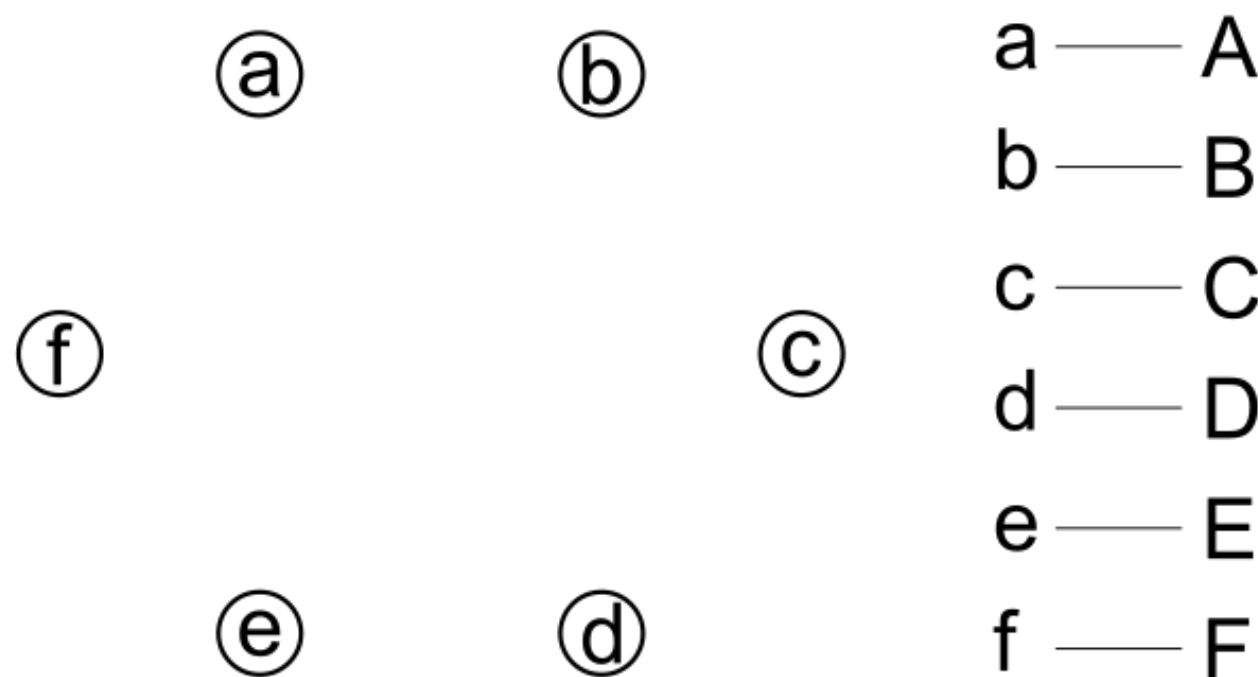

Top-Trading Cycle Algorithm (TTCA)

[Shapley and Scarf, *JME* 1974 (attributed to David Gale)]

While there is a remaining agent:

- Each remaining agent points to the owner of its favorite house.
- There must be a cycle (include self-loops). Do the cyclic exchange.
- Remove the agents and houses involved in the above exchange.

	a	b	c	d	e	f				
1.	B	F	A	E	C	F	(a)	(b)	a — A	
2.									b — B	
3.				(f)				(c)	c — C	
4.									d — D	
5.									e — E	
6.					(e)			(d)	f — F	

Top-Trading Cycle Algorithm (TTCA)

[Shapley and Scarf, *JME* 1974 (attributed to David Gale)]

While there is a remaining agent:

- Each remaining agent points to the owner of its favorite house.
- There must be a cycle (include self-loops). Do the cyclic exchange.
- Remove the agents and houses involved in the above exchange.

	a	b	c	d	e	f
1.	B	F	A	E	C	F
2.						
3.						
4.						
5.						
6.						

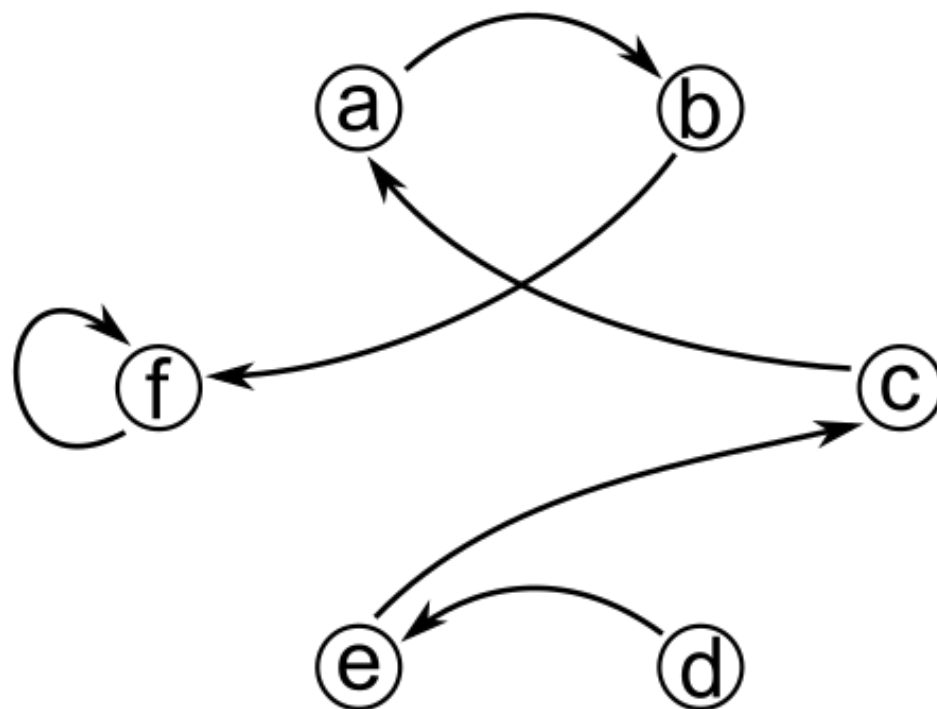

a	—	A
b	—	B
c	—	C
d	—	D
e	—	E
f	—	F

Top-Trading Cycle Algorithm (TTCA)

[Shapley and Scarf, *JME* 1974 (attributed to David Gale)]

While there is a remaining agent:

- Each remaining agent points to the owner of its favorite house.
- There must be a cycle (include self-loops). Do the cyclic exchange.
- Remove the agents and houses involved in the above exchange.

	a	b	c	d	e	f
1.	B	F	A	E	C	F
2.						
3.						
4.						
5.						
6.						

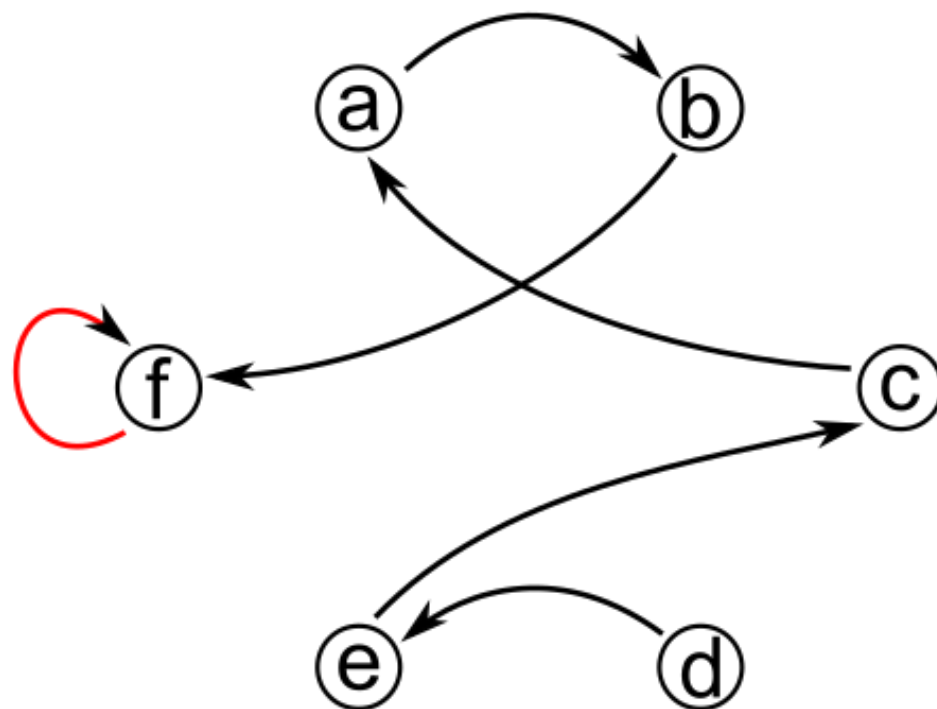

a	—	A
b	—	B
c	—	C
d	—	D
e	—	E
f	—	F

Top-Trading Cycle Algorithm (TTCA)

[Shapley and Scarf, *JME* 1974 (attributed to David Gale)]

While there is a remaining agent:

- Each remaining agent points to the owner of its favorite house.
- There must be a cycle (include self-loops). Do the cyclic exchange.
- Remove the agents and houses involved in the above exchange.

	a	b	c	d	e	f
1.	B	F	A	E	C	F
2.						
3.						
4.						
5.						
6.						

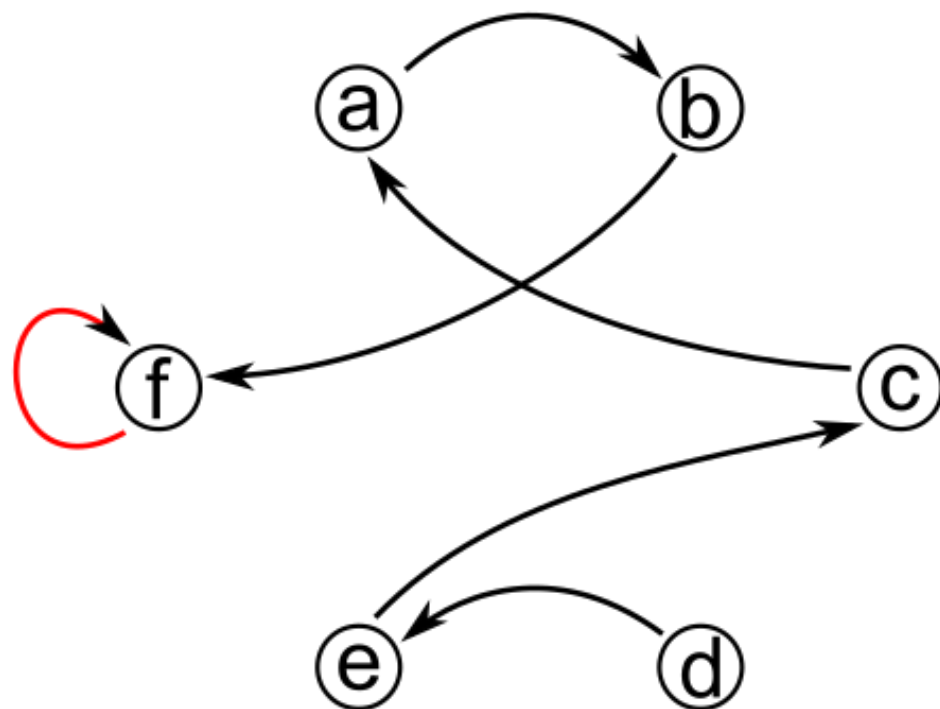

a	—	A
b	—	B
c	—	C
d	—	D
e	—	E
f	—	F

Top-Trading Cycle Algorithm (TTCA)

[Shapley and Scarf, *JME* 1974 (attributed to David Gale)]

While there is a remaining agent:

- Each remaining agent points to the owner of its favorite house.
- There must be a cycle (include self-loops). Do the cyclic exchange.
- Remove the agents and houses involved in the above exchange.

	a	b	c	d	e
1.	B		A	E	C
2.					
3.					
4.					
5.					
6.					

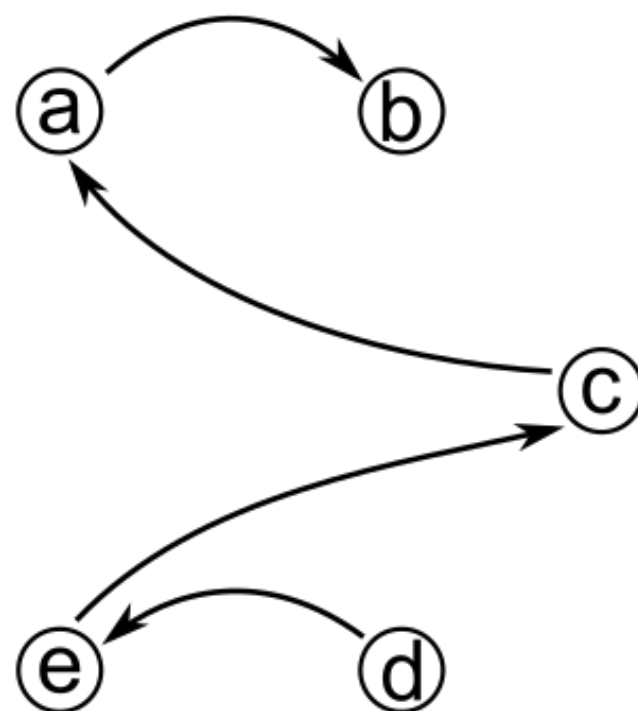

a	—	A
b	—	B
c	—	C
d	—	D
e	—	E
f	—	F

Top-Trading Cycle Algorithm (TTCA)

[Shapley and Scarf, *JME* 1974 (attributed to David Gale)]

While there is a remaining agent:

- Each remaining agent points to the owner of its favorite house.
- There must be a cycle (include self-loops). Do the cyclic exchange.
- Remove the agents and houses involved in the above exchange.

	a	b	c	d	e
1.	B		A	E	C
2.		C			
3.					
4.					
5.					
6.					

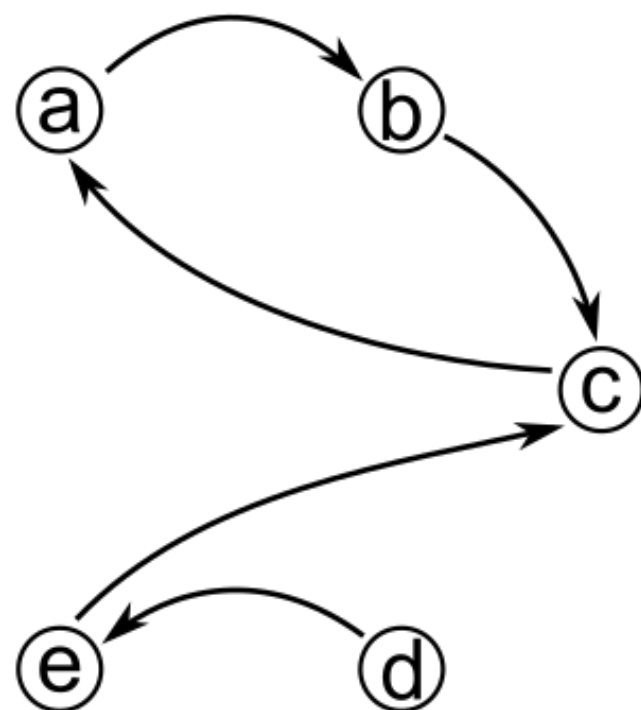

a	—	A
b	—	B
c	—	C
d	—	D
e	—	E
f	—	F

Top-Trading Cycle Algorithm (TTCA)

[Shapley and Scarf, *JME* 1974 (attributed to David Gale)]

While there is a remaining agent:

- Each remaining agent points to the owner of its favorite house.
- There must be a cycle (include self-loops). Do the cyclic exchange.
- Remove the agents and houses involved in the above exchange.

	a	b	c	d	e
1.	B		A	E	C
2.		C			
3.					
4.					
5.					
6.					

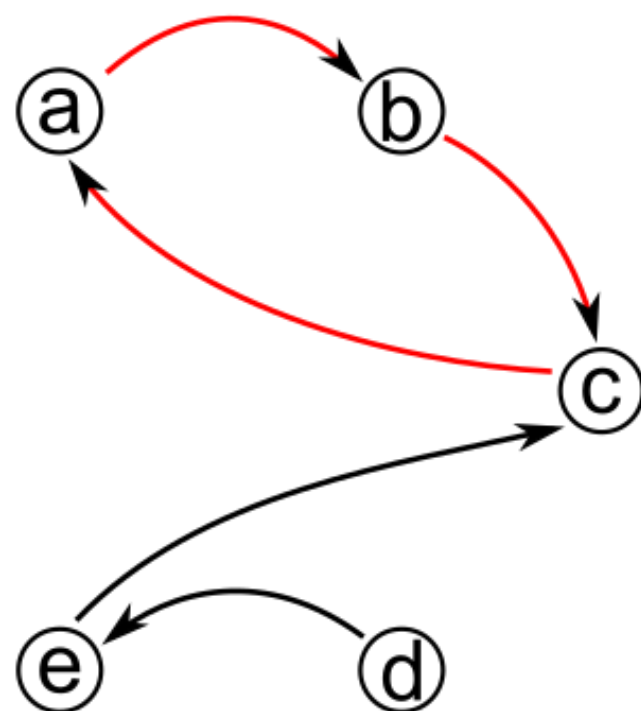

a	—	A
b	—	B
c	—	C
d	—	D
e	—	E
f	—	F

Top-Trading Cycle Algorithm (TTCA)

[Shapley and Scarf, *JME* 1974 (attributed to David Gale)]

While there is a remaining agent:

- Each remaining agent points to the owner of its favorite house.
- There must be a cycle (include self-loops). Do the cyclic exchange.
- Remove the agents and houses involved in the above exchange.

	a	b	c	d	e
1.	B		A	E	C
2.		C			
3.					
4.					
5.					
6.					

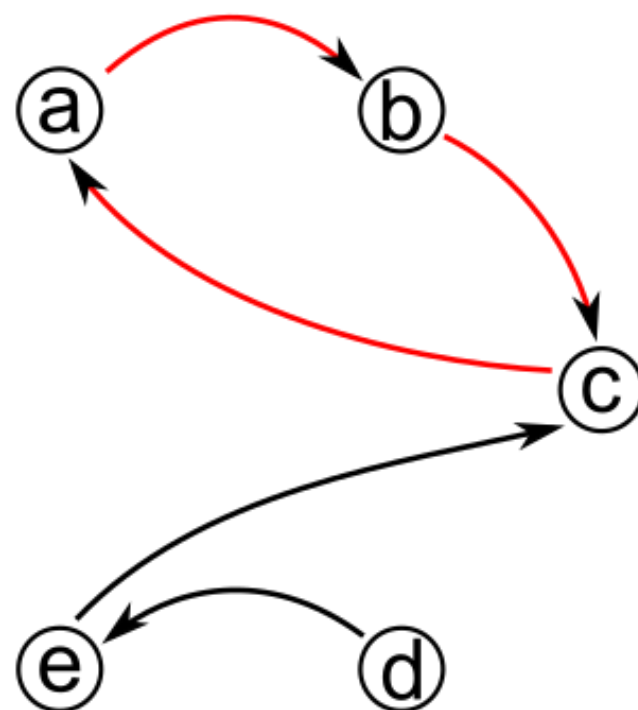

a	—	B
b	—	C
c	—	A
d	—	D
e	—	E
f	—	F

Top-Trading Cycle Algorithm (TTCA)

[Shapley and Scarf, *JME* 1974 (attributed to David Gale)]

While there is a remaining agent:

- Each remaining agent points to the owner of its favorite house.
- There must be a cycle (include self-loops). Do the cyclic exchange.
- Remove the agents and houses involved in the above exchange.

		d	e
1.	_____	E	
2.			
3.			
4.			
5.			
6.			

a	—	B
b	—	C
c	—	A
d	—	D
e	—	E
f	—	F



Top-Trading Cycle Algorithm (TTCA)

[Shapley and Scarf, *JME* 1974 (attributed to David Gale)]

While there is a remaining agent:

- Each remaining agent points to the owner of its favorite house.
- There must be a cycle (include self-loops). Do the cyclic exchange.
- Remove the agents and houses involved in the above exchange.

		d	e
1.	_____	E	
2.			
3.			
4.		D	
5.			
6.		E	

a	—	B
b	—	C
c	—	A
d	—	D
e	—	E
f	—	F



Top-Trading Cycle Algorithm (TTCA)

[Shapley and Scarf, *JME* 1974 (attributed to David Gale)]

While there is a remaining agent:

- Each remaining agent points to the owner of its favorite house.
- There must be a cycle (include self-loops). Do the cyclic exchange.
- Remove the agents and houses involved in the above exchange.

		d	e
1.	_____	E	
2.			
3.			
4.		D	
5.			
6.		E	

a	—	B
b	—	C
c	—	A
d	—	E
e	—	D
f	—	F



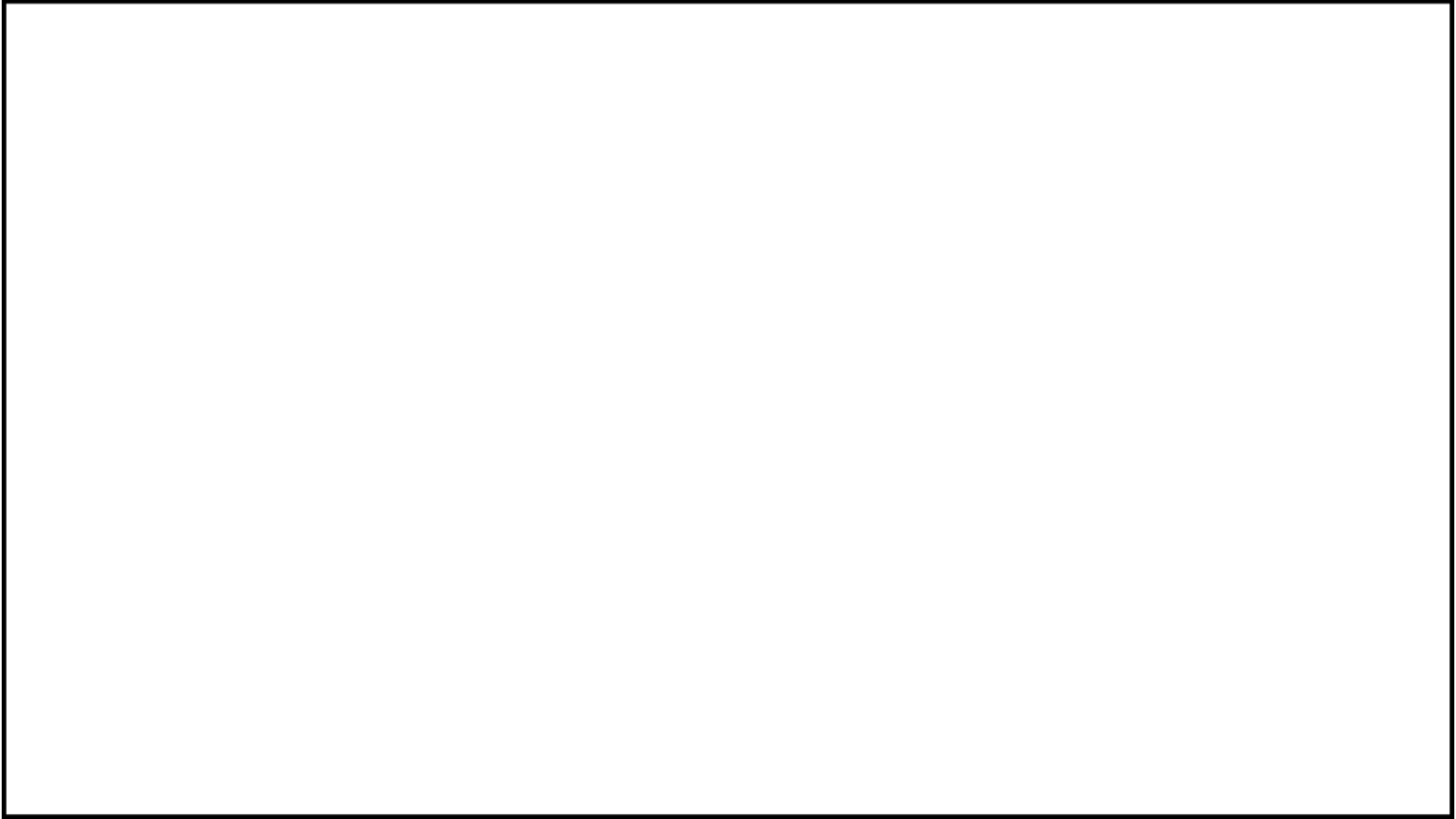

Q1. Is a cyclic exchange always possible?

Q1. Is a cyclic exchange always possible? Yes.

Imagine a graph where the *vertices* are the (remaining) agents and the *edge* $i \rightarrow j$ means that agent i 's favorite house is owned by agent j .

At each step, each vertex has an outgoing edge.

With finitely many vertices, there must exist a cycle.

Q1. Is a cyclic exchange always possible? Yes.

Imagine a graph where the *vertices* are the (remaining) agents and the *edge* $i \rightarrow j$ means that agent i 's favorite house is owned by agent j .

At each step, each vertex has an outgoing edge.

With finitely many vertices, there must exist a cycle.

Q2. Does TTCA always terminate?

Q1. **Is a cyclic exchange always possible?** Yes.

Imagine a graph where the *vertices* are the (remaining) agents and the *edge* $i \rightarrow j$ means that agent i 's favorite house is owned by agent j .

At each step, each vertex has an outgoing edge.

With finitely many vertices, there must exist a cycle.

Q2. **Does TTCA always terminate?** Yes.

At least one agent kicked out in each round.

Q1. **Is a cyclic exchange always possible?** Yes.

Imagine a graph where the *vertices* are the (remaining) agents and the *edge* $i \rightarrow j$ means that agent i 's favorite house is owned by agent j .

At each step, each vertex has an outgoing edge.

With finitely many vertices, there must exist a cycle.

Q2. **Does TTCA always terminate?** Yes.

At least one agent kicked out in each round.

Q3. **Does TTCA terminate in polynomial time?**

Q1. **Is a cyclic exchange always possible?** Yes.

Imagine a graph where the *vertices* are the (remaining) agents and the *edge* $i \rightarrow j$ means that agent i 's favorite house is owned by agent j .

At each step, each vertex has an outgoing edge.

With finitely many vertices, there must exist a cycle.

Q2. **Does TTCA always terminate?** Yes.

At least one agent kicked out in each round.

Q3. **Does TTCA terminate in polynomial time?** Yes.

TTCA is strategyproof

[Roth, *Econ. Letters* 1982]

TTCA is strategyproof

[Roth, *Econ. Letters* 1982]

Let S_k denote the set of agents who are removed in round k of TTCA.

TTCA is strategyproof

[Roth, *Econ. Letters* 1982]

Let S_k denote the set of agents who are removed in round k of TTCA.

S_1



S_2



TTCA is strategyproof

[Roth, *Econ. Letters* 1982]

Let S_k denote the set of agents who are removed in round k of TTCA.

Each agent in S_1 gets its favorite house and therefore has no incentive to misreport.

S_1



S_2



TTCA is strategyproof

[Roth, *Econ. Letters* 1982]

Let S_k denote the set of agents who are removed in round k of TTCA.

Each agent in S_1 gets its favorite house and therefore has no incentive to misreport.

Subject to that, no agent in S_2 has any incentive to misreport.

S_1



S_2



TTCA is strategyproof

[Roth, *Econ. Letters* 1982]

Let S_k denote the set of agents who are removed in round k of TTCA.

Each agent in S_1 gets its favorite house and therefore has no incentive to misreport.

Subject to that, no agent in S_2 has any incentive to misreport.

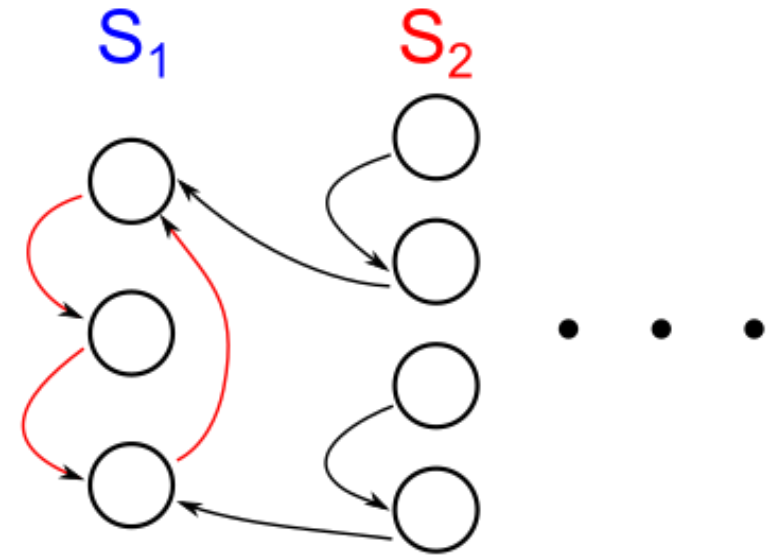

TTCA is strategyproof

[Roth, *Econ. Letters* 1982]

Let S_k denote the set of agents who are removed in round k of TTCA.

Each agent in S_1 gets its favorite house and therefore has no incentive to misreport.

Subject to that, no agent in S_2 has any incentive to misreport.

- No agent in S_2 can get a house owned by an agent in S_1 since, in round 1, no agent in S_1 points to an agent in S_2 .

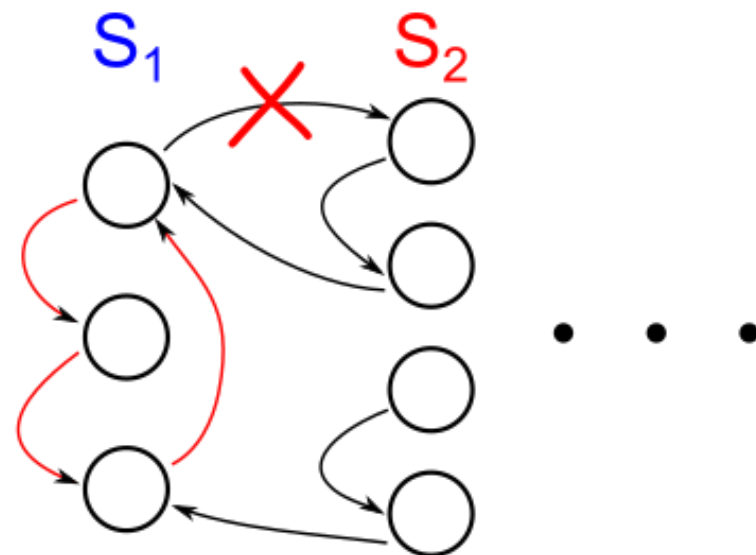

TTCA is strategyproof

[Roth, *Econ. Letters* 1982]

Let S_k denote the set of agents who are removed in round k of TTCA.

Each agent in S_1 gets its favorite house and therefore has no incentive to misreport.

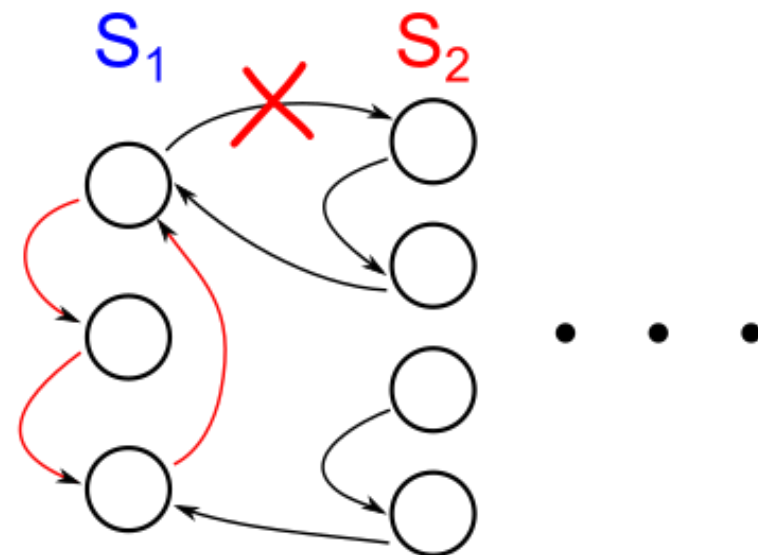

Subject to that, no agent in S_2 has any incentive to misreport.

- No agent in S_2 can get a house owned by an agent in S_1 since, in round 1, no agent in S_1 points to an agent in S_2 .
- So, each agent in S_2 gets its favorite house among the remaining ones.

TTCA is strategyproof

[Roth, *Econ. Letters* 1982]

Let S_k denote the set of agents who are removed in round k of TTCA.

Each agent in S_1 gets its favorite house and therefore has no incentive to misreport.

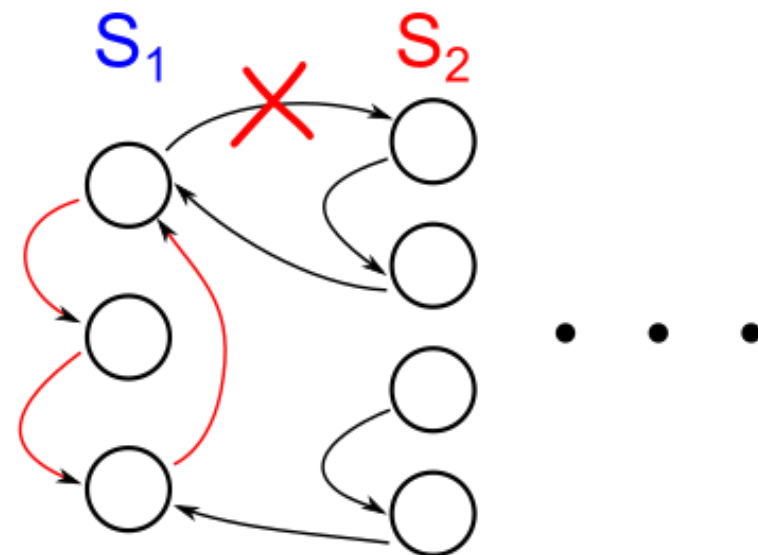

Subject to that, no agent in S_2 has any incentive to misreport.

- No agent in S_2 can get a house owned by an agent in S_1 since, in round 1, no agent in S_1 points to an agent in S_2 .
- So, each agent in S_2 gets its favorite house among the remaining ones.

Use induction.

TTCA is strategyproof

[Roth, *Econ. Letters* 1982]

Let S_k denote the set of agents who are removed in round k of TTCA.

Each agent in S_1 gets its favorite house and therefore has no incentive to misreport.

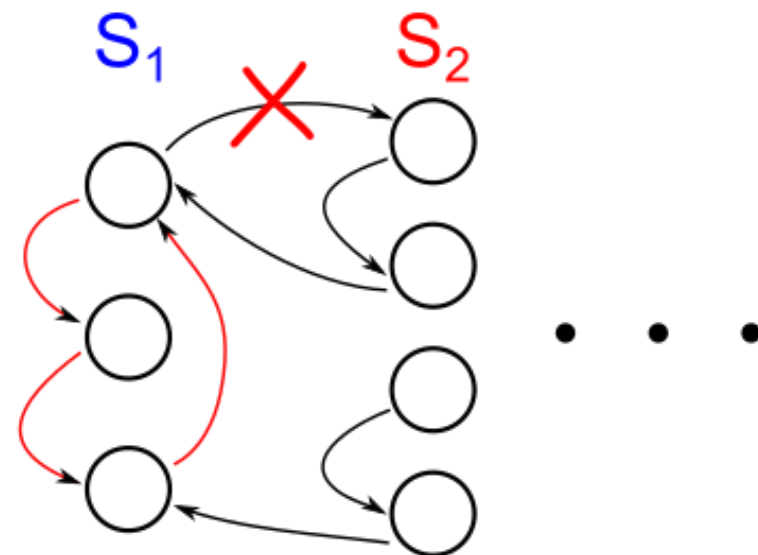

Subject to that, no agent in S_2 has any incentive to misreport.

- No agent in S_2 can get a house owned by an agent in S_1 since, in round 1, no agent in S_1 points to an agent in S_2 .
- So, each agent in S_2 gets its favorite house among the remaining ones.

Use induction. ■

The Core

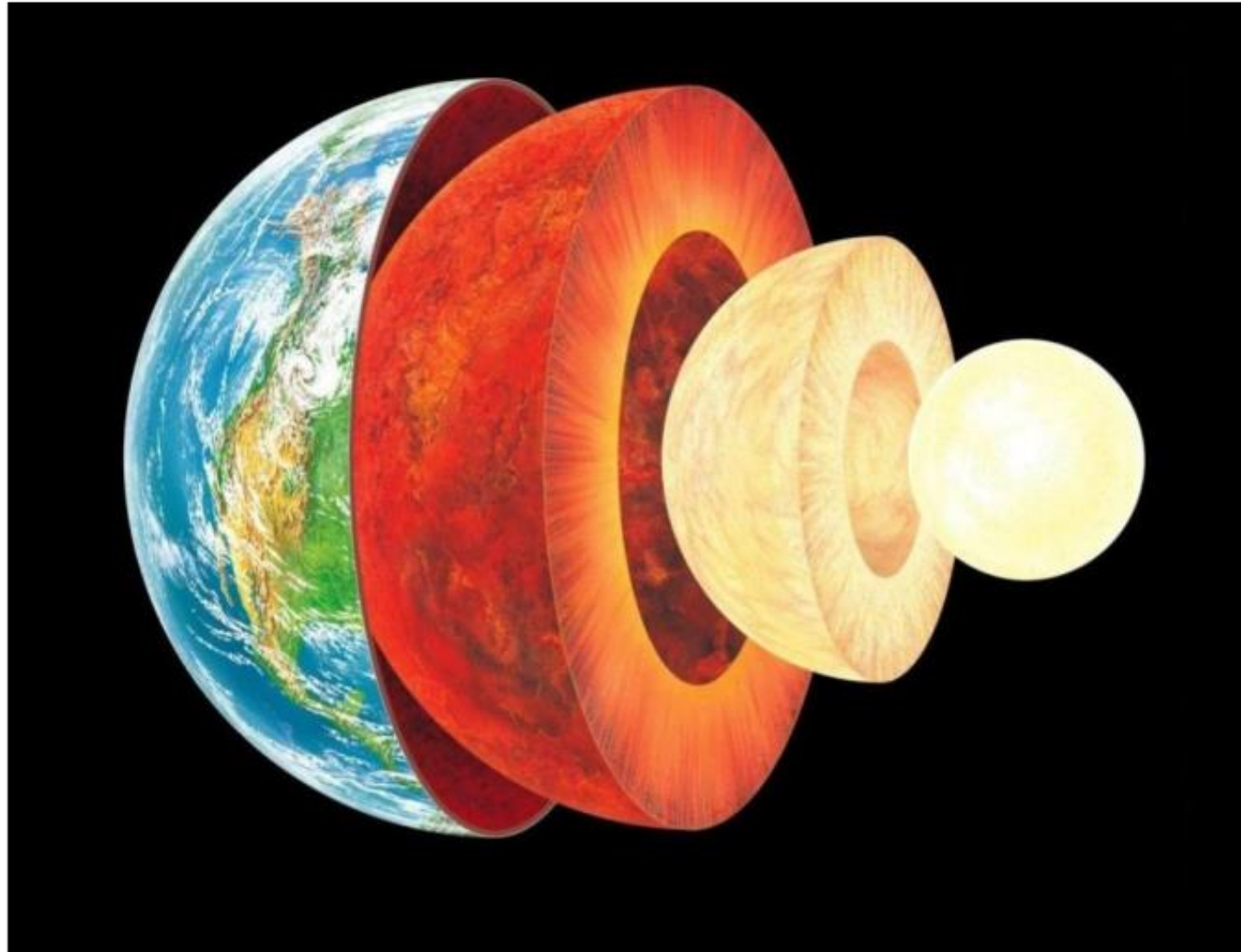

The Core

An allocation is in the **core** if no coalition blocks it.

The Core

An allocation is in the **core** if no coalition blocks it.

A coalition of agents **blocks** an allocation **A** if:

they can redistribute their **endowed houses** among themselves such that, compared to **A**, none of them is worse off and at least one of them is strictly better off (i.e., redistributing endowments is a Pareto improvement over **A**).

Example of a Core Allocation

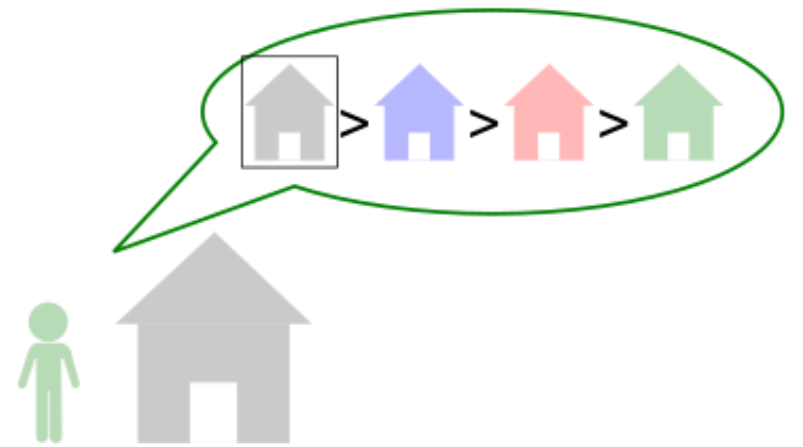
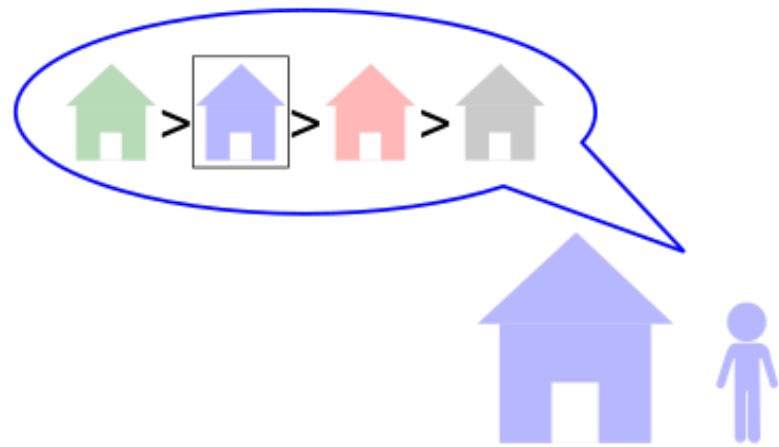
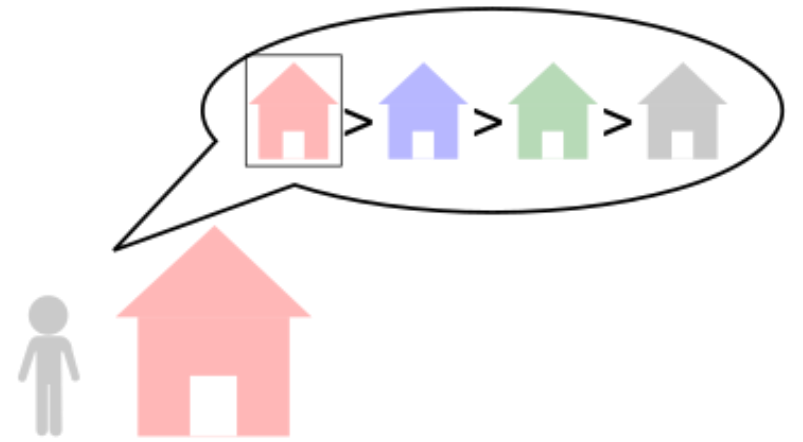
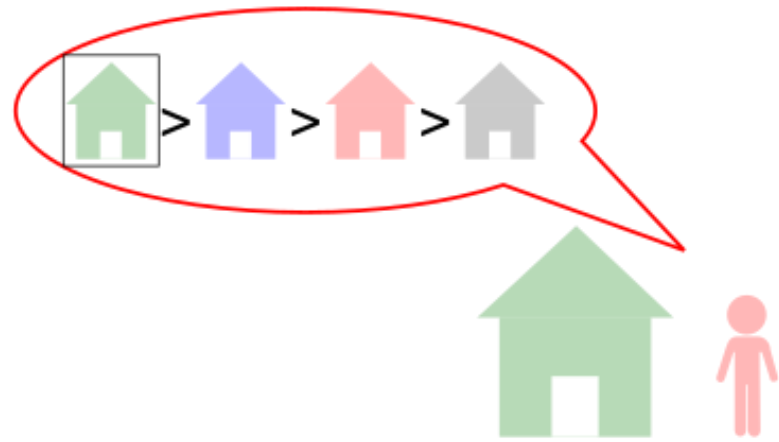

TTCA outcome is in the core.

[Shapley and Scarf, *JME* 1974 (attributed to David Gale)]

TTCA outcome is in the core.

[Shapley and Scarf, *JME* 1974 (attributed to David Gale)]

Suppose not. Then, a coalition C of agents must block the TTCA allocation T . Let R be a redistribution of endowments among agents in C that they find Pareto better than T .

TTCA outcome is in the core.

[Shapley and Scarf, *JME* 1974 (attributed to David Gale)]

Suppose not. Then, a coalition C of agents must block the TTCA allocation T . Let R be a redistribution of endowments among agents in C that they find Pareto better than T .

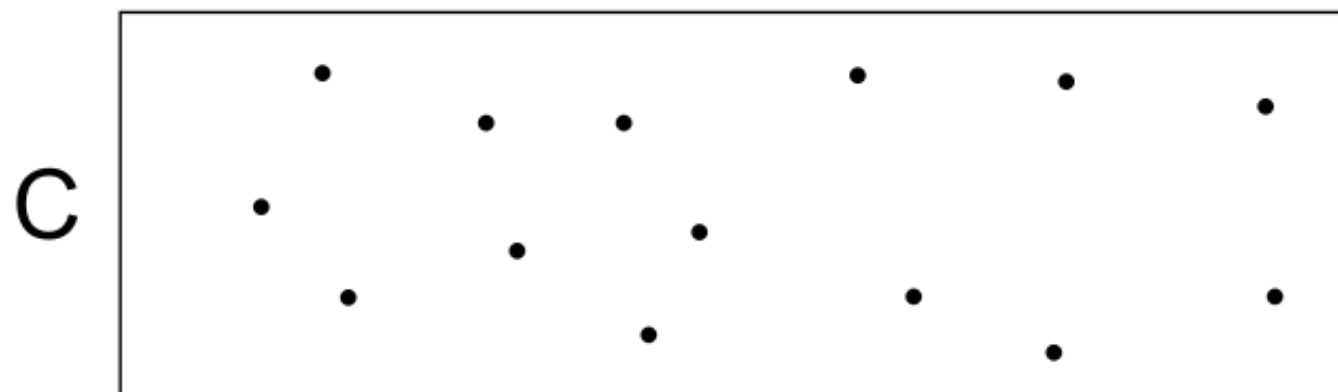

T = TTCA outcome, R = redistribution of endowments within C

TTCA outcome is in the core.

[Shapley and Scarf, *JME* 1974 (attributed to David Gale)]

Let $C^+ \subseteq C$ be the agents in C who *strictly prefer* R over T .

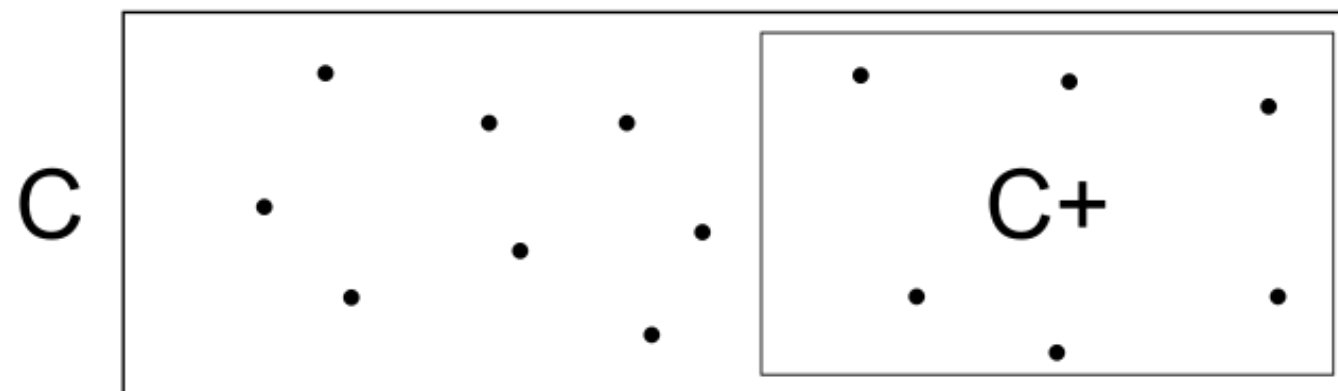

T = TTCA outcome, R = redistribution of endowments within C

TTCA outcome is in the core.

[Shapley and Scarf, *JME* 1974 (attributed to David Gale)]

Let $C^+ \subseteq C$ be the agents in C who *strictly prefer* R over T .

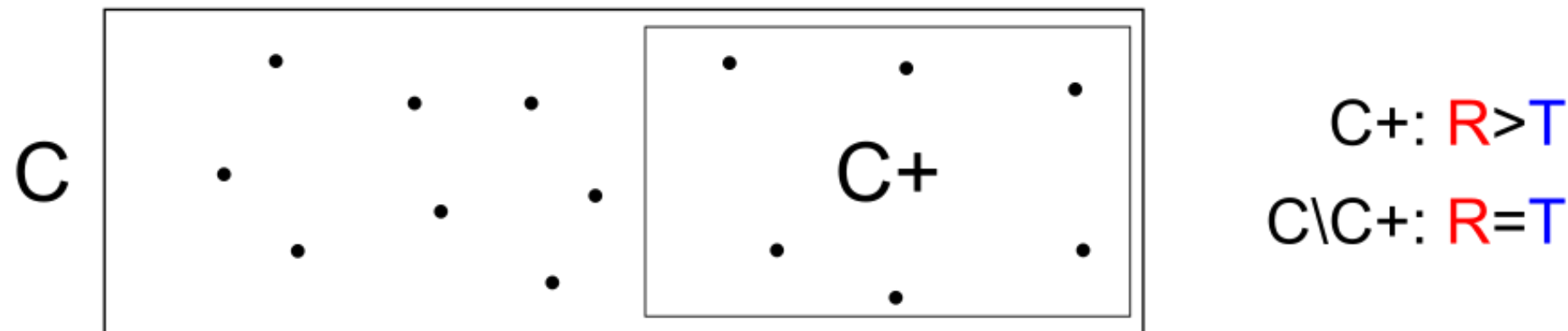

T = TTCA outcome, R = redistribution of endowments within C

TTCA outcome is in the core.

[Shapley and Scarf, *JME* 1974 (attributed to David Gale)]

Let $x \in C^+$ be the agent in C^+ who is the *earliest* to be eliminated under TTCA (say, in round r).

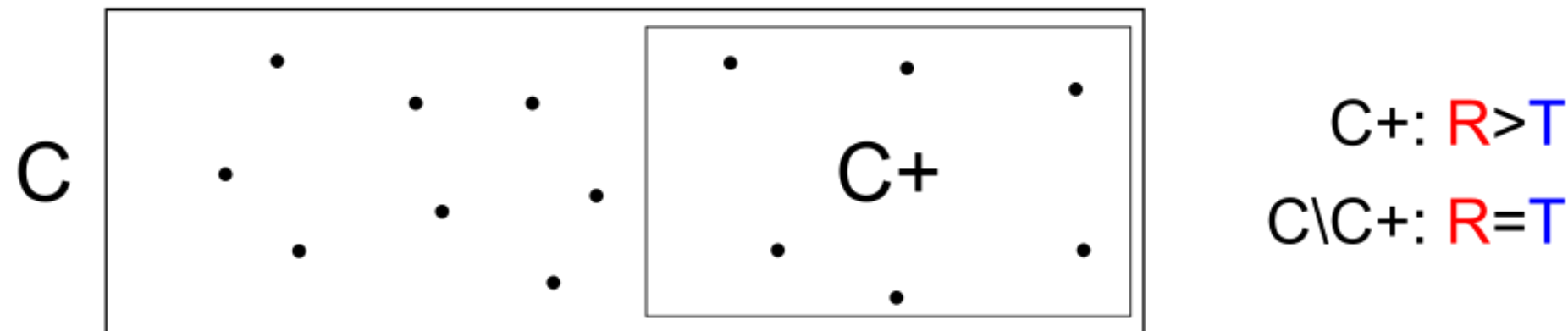

T = TTCA outcome, R = redistribution of endowments within C

TTCA outcome is in the core.

[Shapley and Scarf, *JME* 1974 (attributed to David Gale)]

Let $x \in C^+$ be the agent in C^+ who is the *earliest* to be eliminated under TTCA (say, in round r).

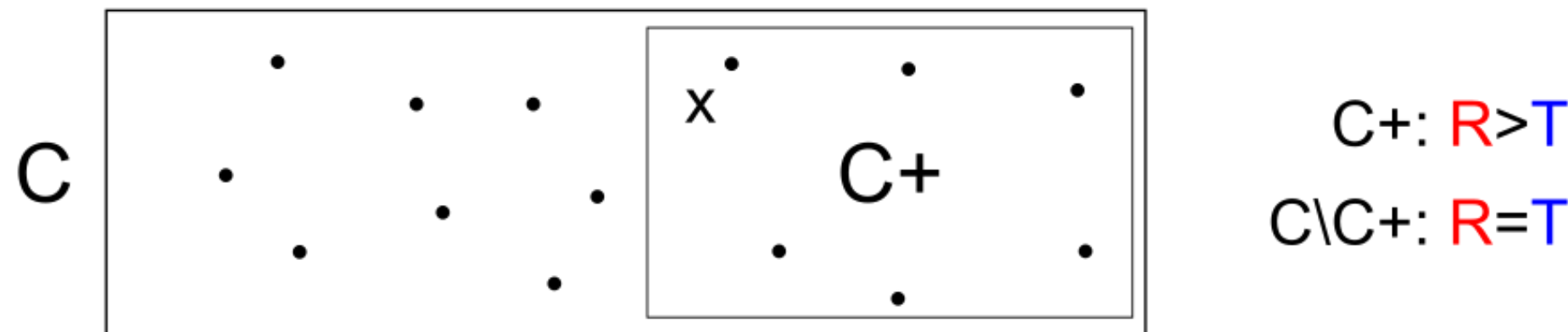

T = TTCA outcome, R = redistribution of endowments within C

TTCA outcome is in the core.

[Shapley and Scarf, *JME* 1974 (attributed to David Gale)]

At the time x is eliminated (round r), all agents in C^+ are still available under TTCA along with their endowed houses.

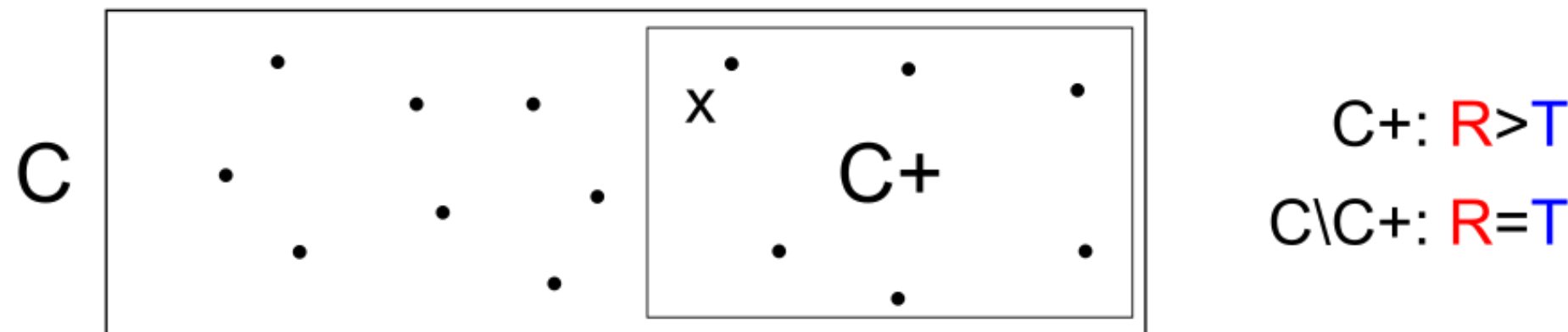

T = TTCA outcome, R = redistribution of endowments within C

TTCA outcome is in the core.

[Shapley and Scarf, *JME* 1974 (attributed to David Gale)]

The house x gets under T is at least as good (according to x 's preference) as the endowed house of any agent in C^+ .

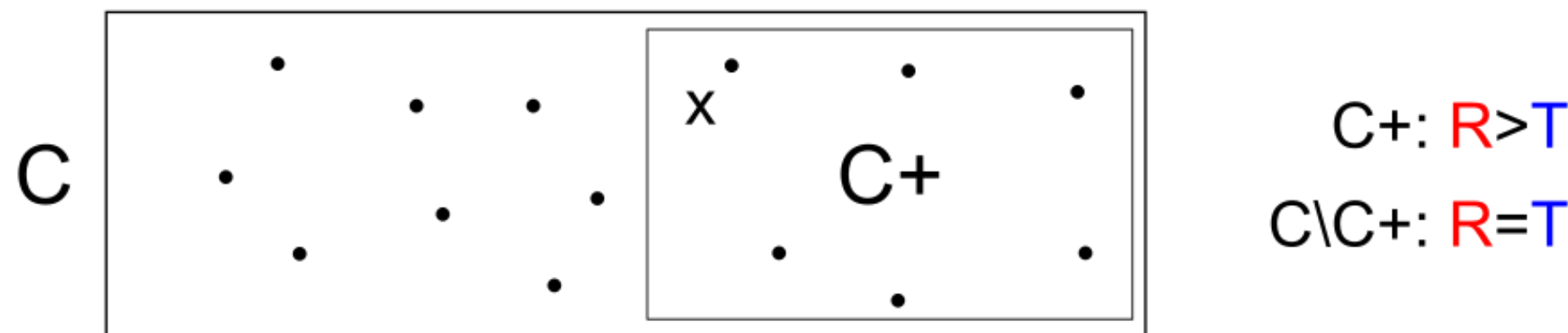

T = TTCA outcome, R = redistribution of endowments within C

TTCA outcome is in the core.

[Shapley and Scarf, *JME* 1974 (attributed to David Gale)]

The house x gets under R is strictly better (according to x 's preference) than the endowed house of any agent in C^+ .

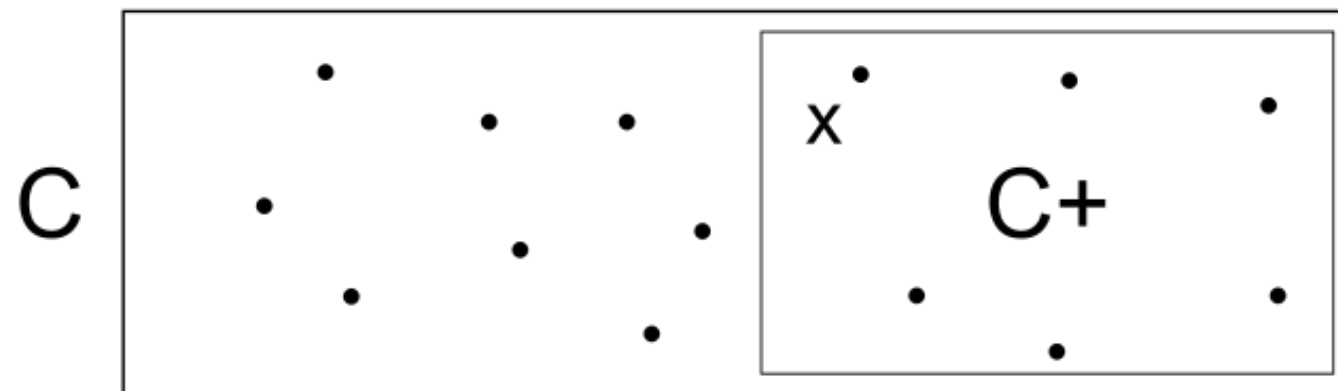

C^+ : $R > T$

$C \setminus C^+$: $R = T$

T = TTCA outcome, R = redistribution of endowments within C

TTCA outcome is in the core.

[Shapley and Scarf, *JME* 1974 (attributed to David Gale)]

The house x gets under R must be the endowed house of some agent $y \in C \setminus C^+$.

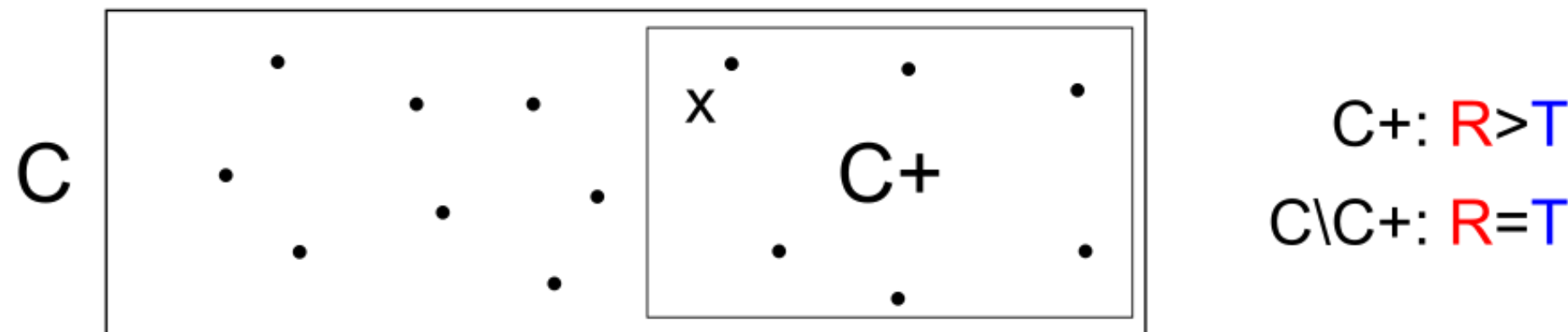

T = TTCA outcome, R = redistribution of endowments within C

TTCA outcome is in the core.

[Shapley and Scarf, *JME* 1974 (attributed to David Gale)]

The house x gets under R must be the endowed house of some agent $y \in C \setminus C^+$.

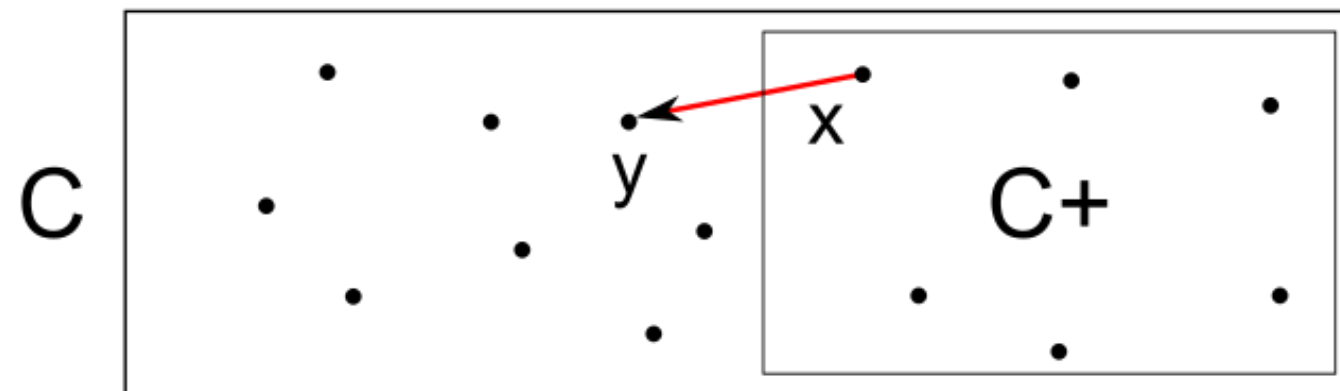

C^+ : $R > T$
 $C \setminus C^+$: $R = T$

T = TTCA outcome, R = redistribution of endowments within C

TTCA outcome is in the core.

[Shapley and Scarf, *JME* 1974 (attributed to David Gale)]

Then, under TTCA, agent y must have been eliminated in round $r-1$ or earlier (i.e., strictly before x).

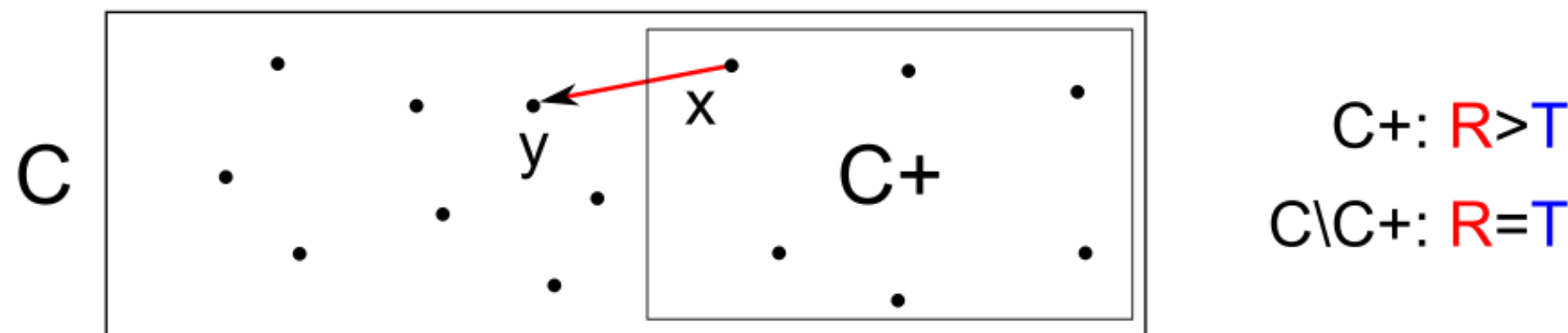

T = TTCA outcome, R = redistribution of endowments within C

TTCA outcome is in the core.

[Shapley and Scarf, *JME* 1974 (attributed to David Gale)]

Agent y cannot get its own endowed house under the TTCA outcome T .

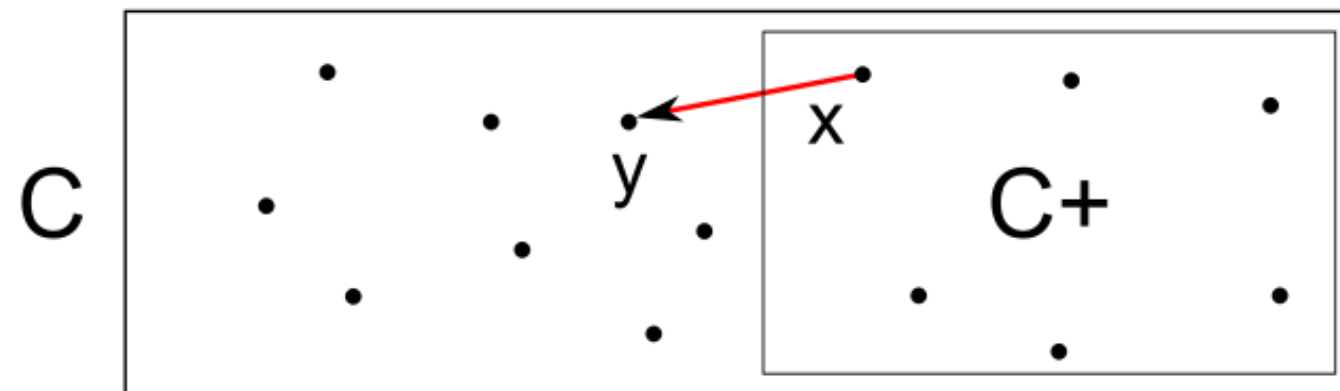

C^+ : $R > T$

$C \setminus C^+$: $R = T$

T = TTCA outcome, R = redistribution of endowments within C

TTCA outcome is in the core.

[Shapley and Scarf, *JME* 1974 (attributed to David Gale)]

So, under **T** (as well as **R**), y gets the endowed house of agent $z \in C$.

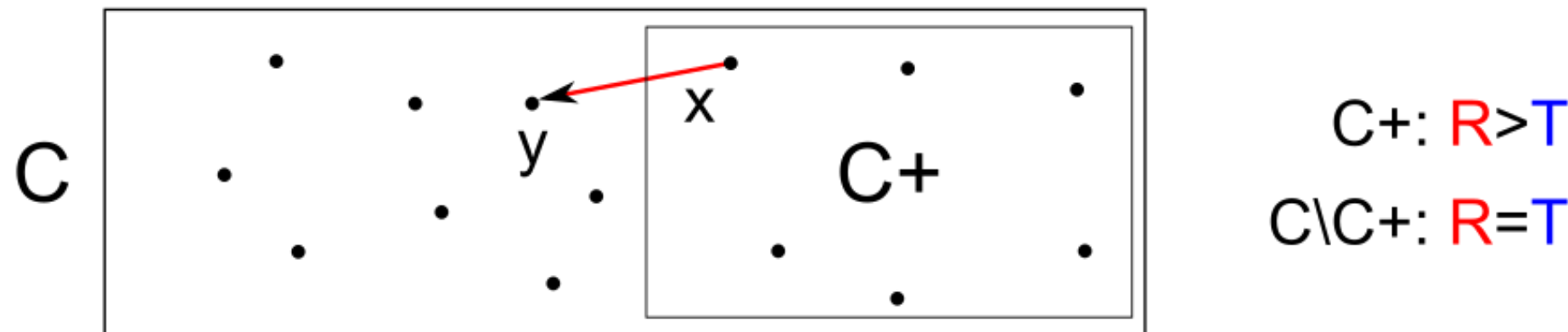

T = TTCA outcome, **R** = redistribution of endowments within C

TTCA outcome is in the core.

[Shapley and Scarf, *JME* 1974 (attributed to David Gale)]

So, under **T** (as well as **R**), y gets the endowed house of agent $z \in C$.

Note that $z \in C \setminus C^+$ by semantics of TTCA.

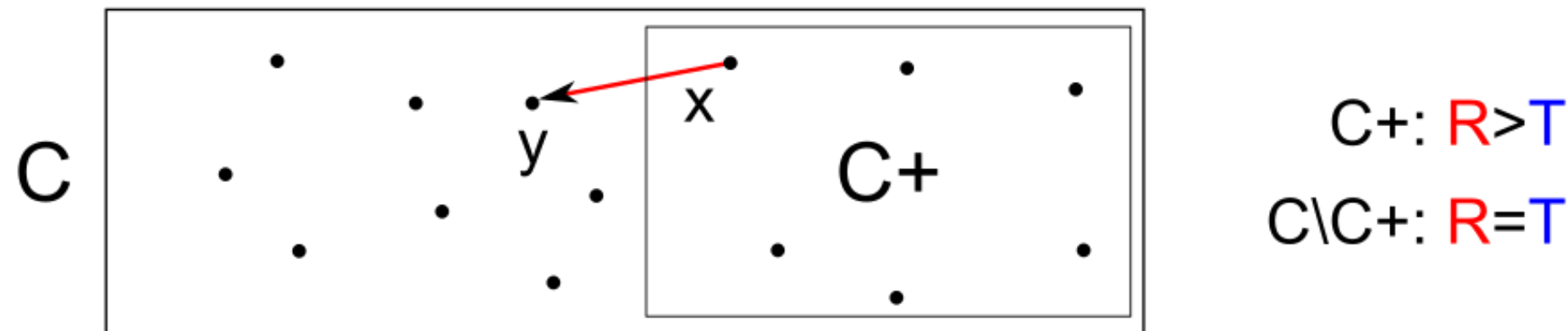

T = TTCA outcome, **R** = redistribution of endowments within C

TTCA outcome is in the core.

[Shapley and Scarf, *JME* 1974 (attributed to David Gale)]

So, under **T** (as well as **R**), y gets the endowed house of agent $z \in C$.

Note that $z \in C \setminus C^+$ by semantics of TTCA.

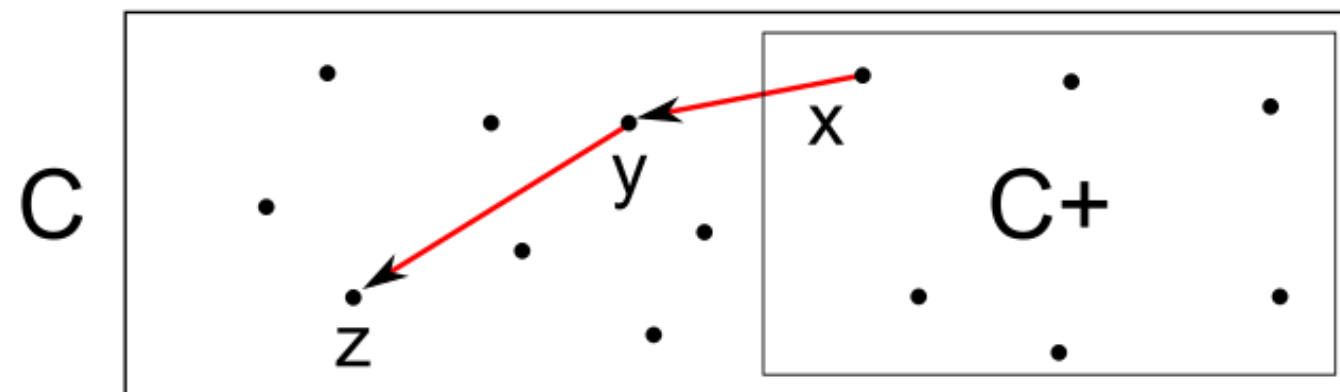

$C^+ : R > T$

$C \setminus C^+ : R = T$

T = TTCA outcome, **R** = redistribution of endowments within C

TTCA outcome is in the core.

[Shapley and Scarf, *JME* 1974 (attributed to David Gale)]

Then, under TTCA, agent z must be eliminated in the *same round* as y .

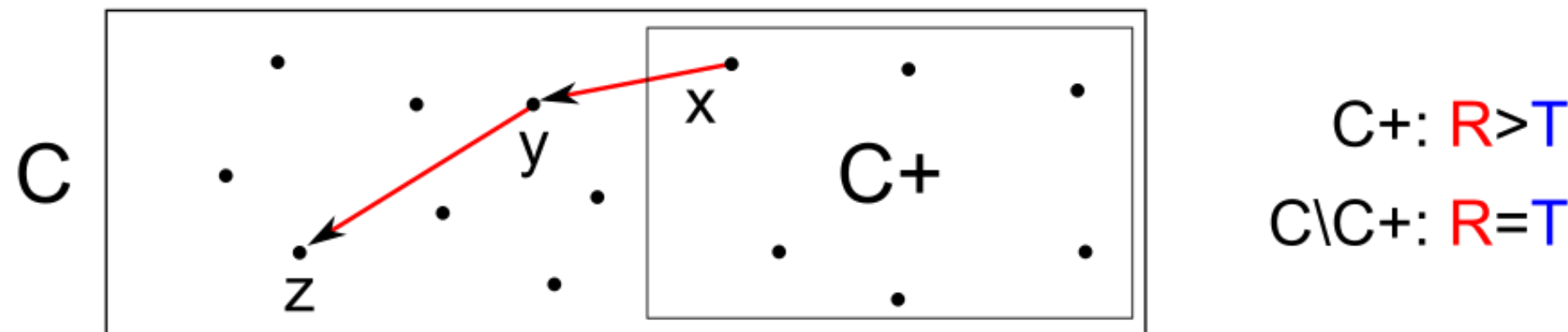

T = TTCA outcome, R = redistribution of endowments within C

TTCA outcome is in the core.

[Shapley and Scarf, *JME* 1974 (attributed to David Gale)]

Then, under TTCA, agent z must be eliminated in the *same round* as y .

That means agent z gets the endowed house of $w \in C \setminus C^+$ such that $w \neq y$.

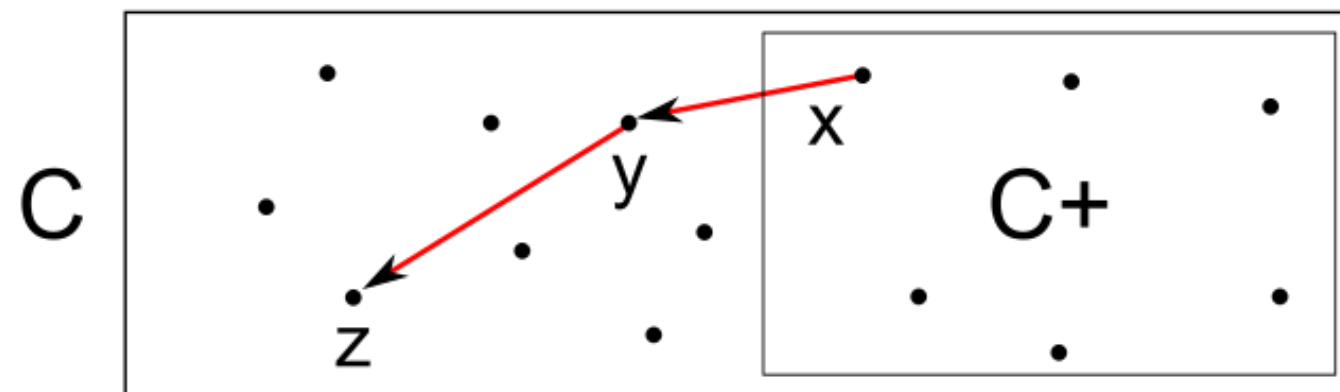

$$C^+: R > T$$

$$C \setminus C^+: R = T$$

T = TTCA outcome, R = redistribution of endowments within C

TTCA outcome is in the core.

[Shapley and Scarf, *JME* 1974 (attributed to David Gale)]

Then, under TTCA, agent z must be eliminated in the *same round* as y .

That means agent z gets the endowed house of $w \in C \setminus C^+$ such that $w \neq y$.

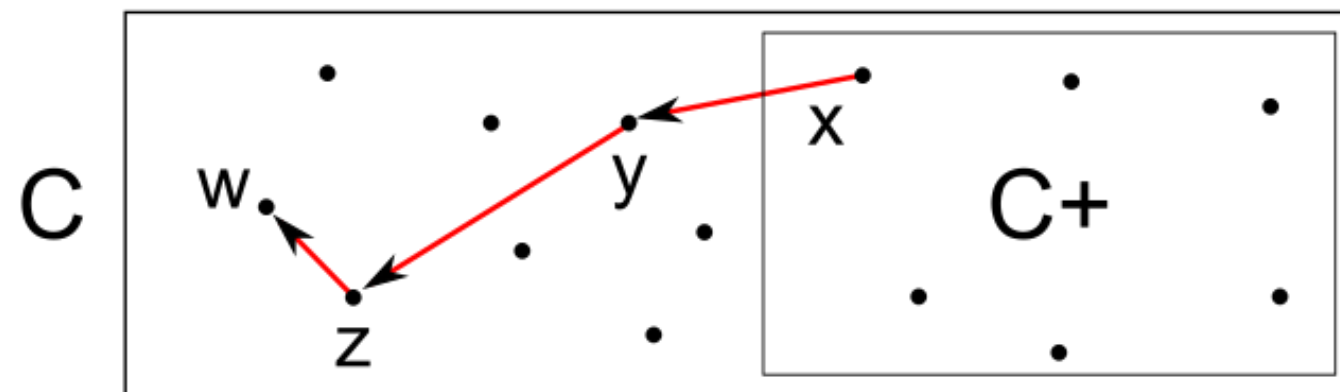

C^+ : $R > T$

$C \setminus C^+$: $R = T$

T = TTCA outcome, R = redistribution of endowments within C

TTCA outcome is in the core.

[Shapley and Scarf, *JME* 1974 (attributed to David Gale)]

Continuing in this manner, we get an "unending" chain within $C \setminus C^+$.

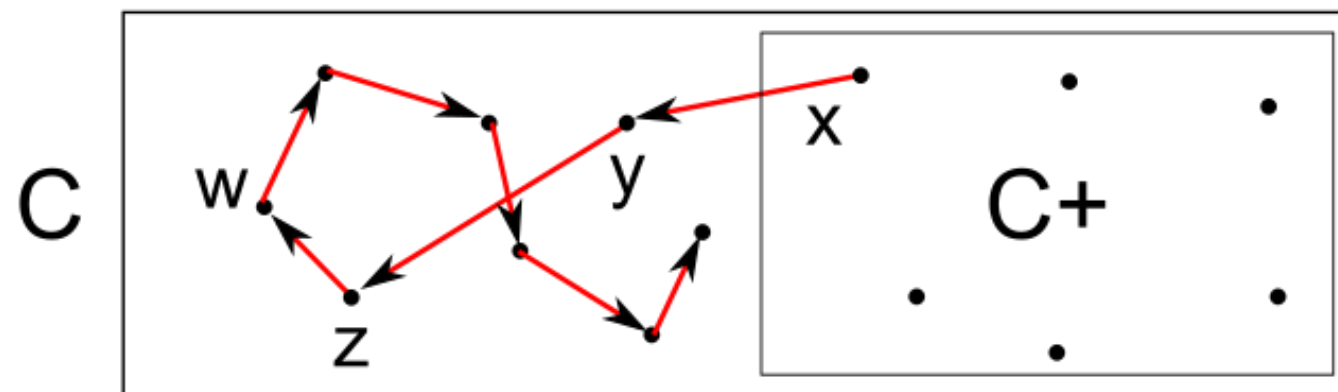

C^+ : $R > T$
 $C \setminus C^+$: $R = T$

T = TTCA outcome, R = redistribution of endowments within C

TTCA outcome is in the core.

[Shapley and Scarf, *JME* 1974 (attributed to David Gale)]

Continuing in this manner, we get an "unending" chain within $C \setminus C^+$.

Contradicts the fact that there is a finite number of agents.

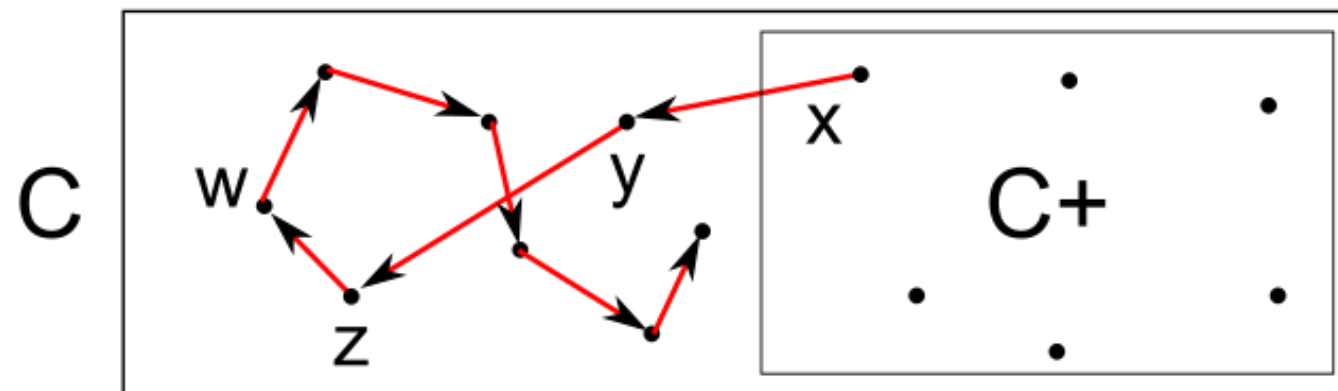

C^+ : $R > T$
 $C \setminus C^+$: $R = T$

T = TTCA outcome, R = redistribution of endowments within C

TTCA outcome is in the core.

[Shapley and Scarf, *JME* 1974 (attributed to David Gale)]

Continuing in this manner, we get an "unending" chain within $C \setminus C^+$.

Contradicts the fact that there is a finite number of agents.

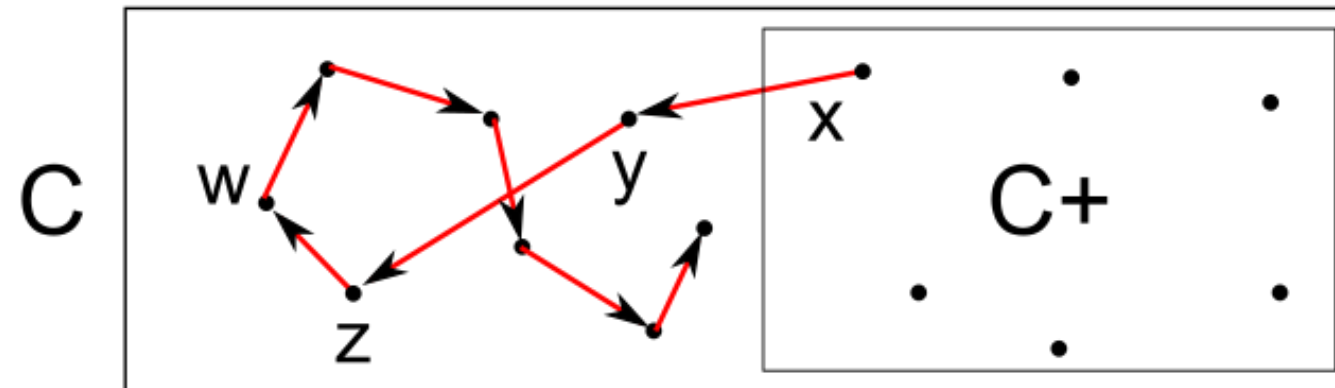

C^+ : $R > T$
 $C \setminus C^+$: $R = T$

T = TTCA outcome, R = redistribution of endowments within C



TTCA outcome is in the core.

[Shapley and Scarf, *JME* 1974 (attributed to David Gale)]

Exercise: Prove that the core outcome is **unique**.

Application of TTCA

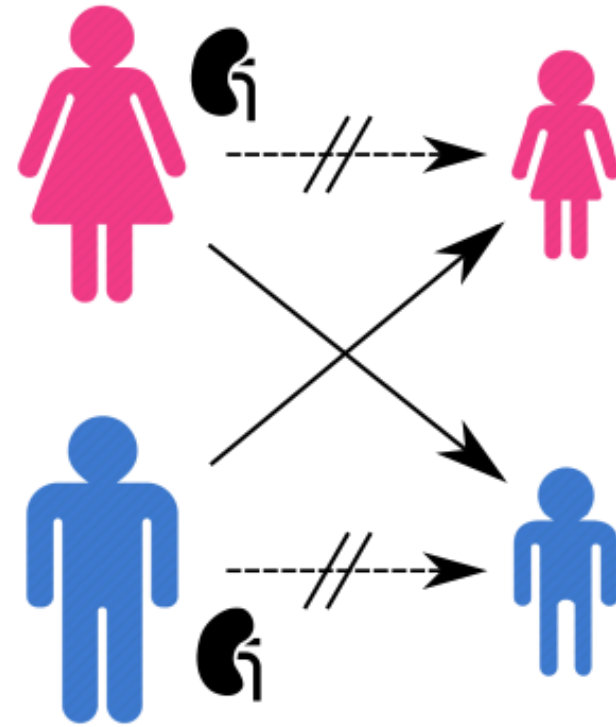

Kidney Exchange

Kidney Exchange

Many people suffer from kidney failure
(waiting list in US: ~90,000; in India: ~200,000).

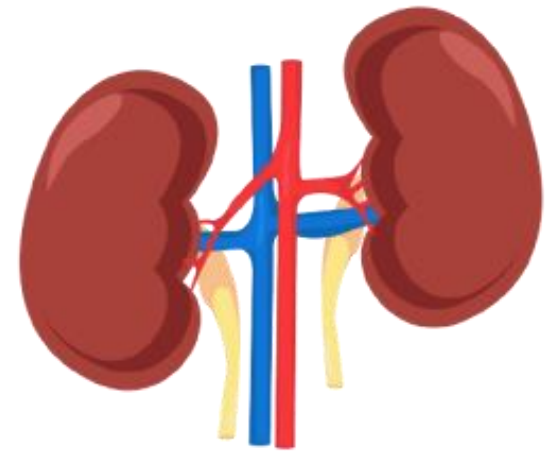

Kidney Exchange

Many people suffer from kidney failure
(waiting list in US: ~90,000; in India: ~200,000).

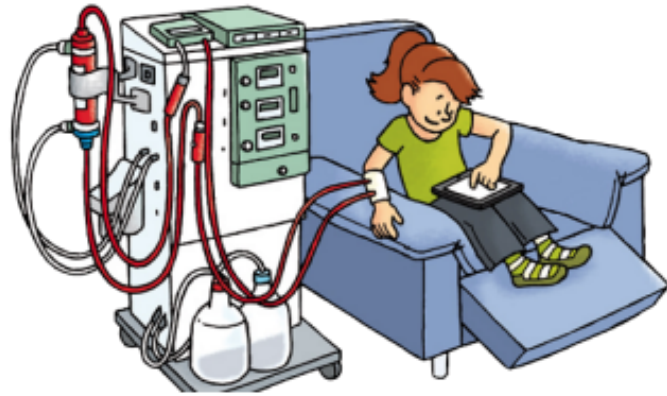
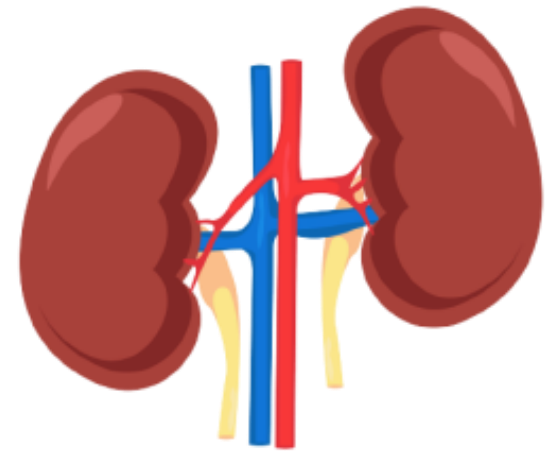

Dialysis

Kidney Exchange

Many people suffer from kidney failure
(waiting list in US: ~90,000; in India: ~200,000).

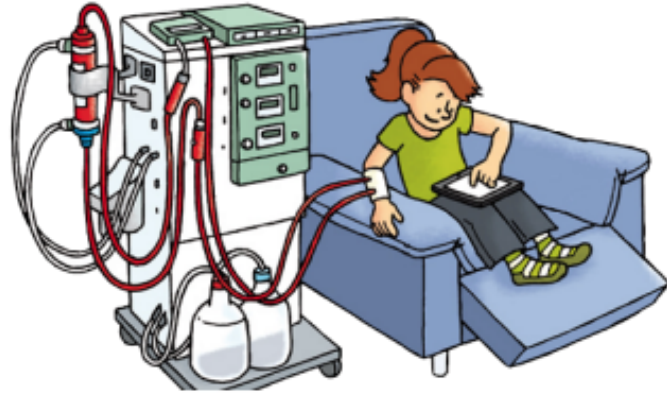
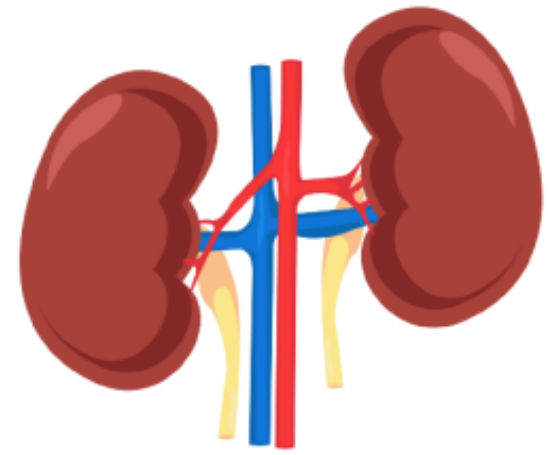

Dialysis

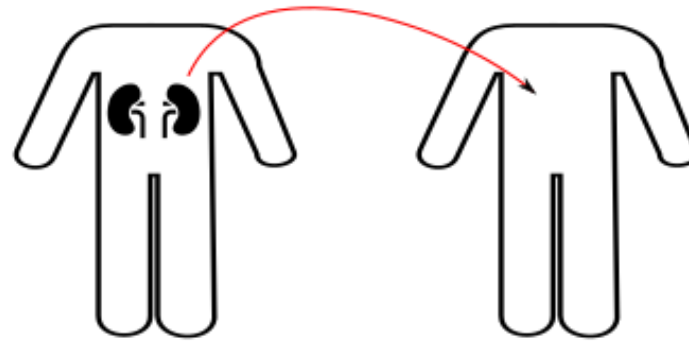

Transplant

Kidney Exchange

Many people suffer from kidney failure
(waiting list in US: ~90,000; in India: ~200,000).

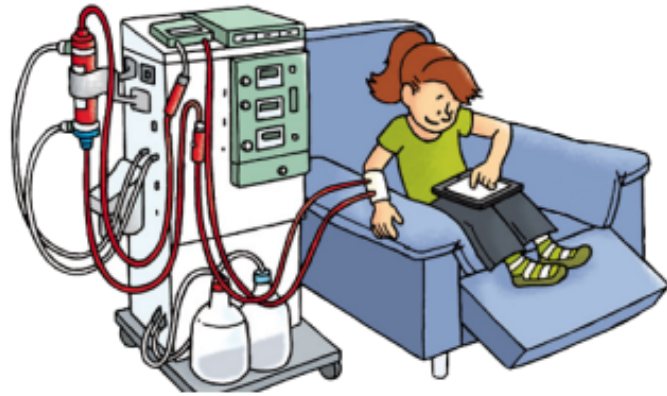
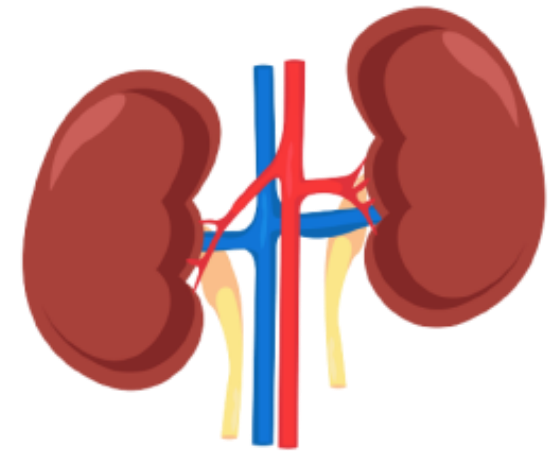

Dialysis

Poor quality of life
High cost

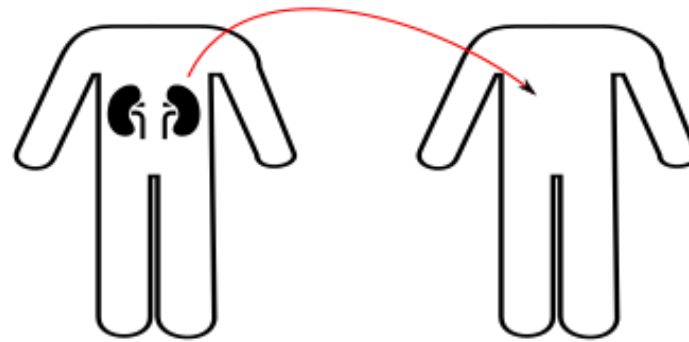

Transplant

Better life quality
Lower cost

Kidney Exchange

Many people suffer from kidney failure
(waiting list in US: ~90,000; in India: ~200,000).

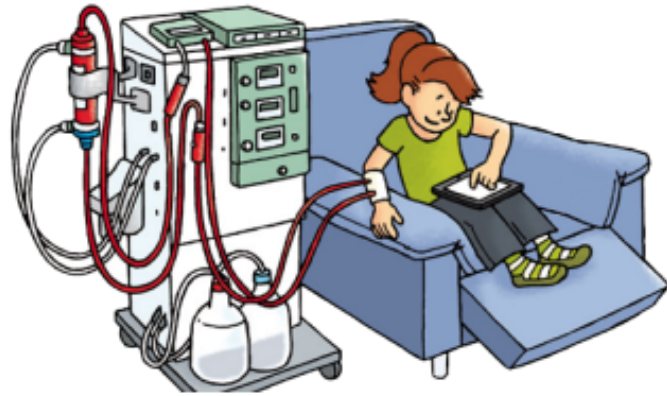
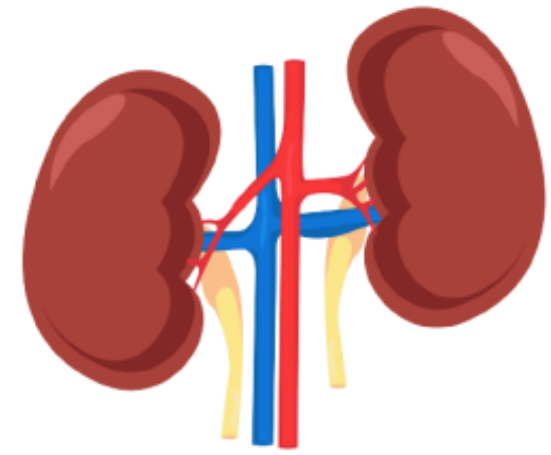

Dialysis

Poor quality of life
High cost

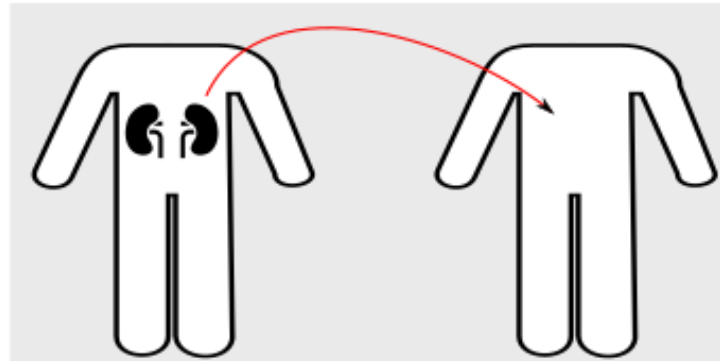

Transplant

Better life quality
Lower cost

- From a **deceased donor**

- From a **living donor**

Kidney Exchange

Many people suffer from kidney failure
(waiting list in US: ~90,000; in India: ~200,000).

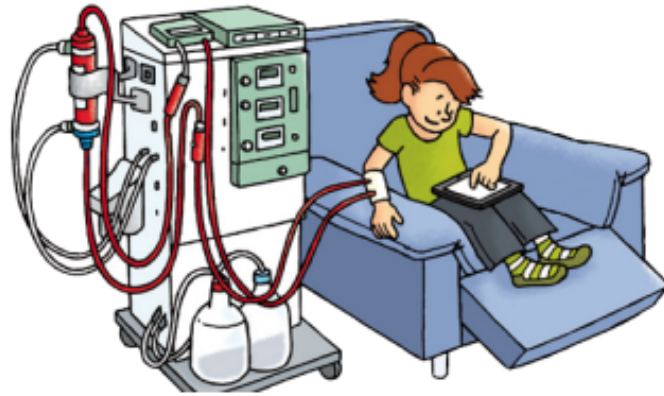
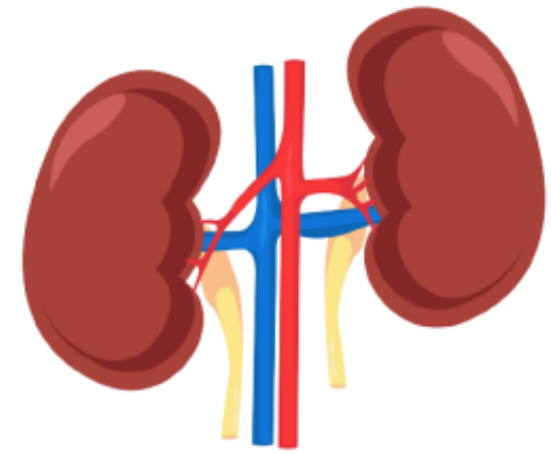

Dialysis

Poor quality of life
High cost

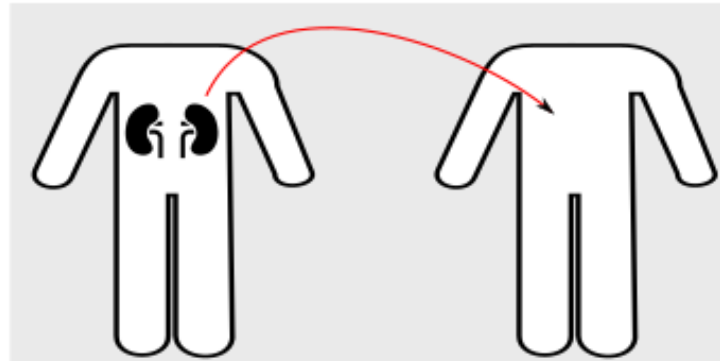

Transplant

Better life quality
Lower cost

- From a **deceased donor**



- From a **living donor**

E.g., first-degree relatives,
spouse etc.

Kidney Exchange

Simply having a willing donor is not enough.
The organ must be **medically compatible**.

Kidney Exchange

Simply having a willing donor is not enough.
The organ must be **medically compatible**.

Blood-type incompatibility

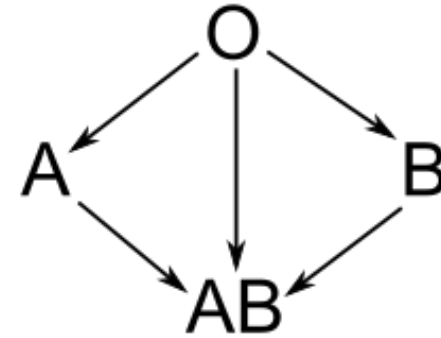
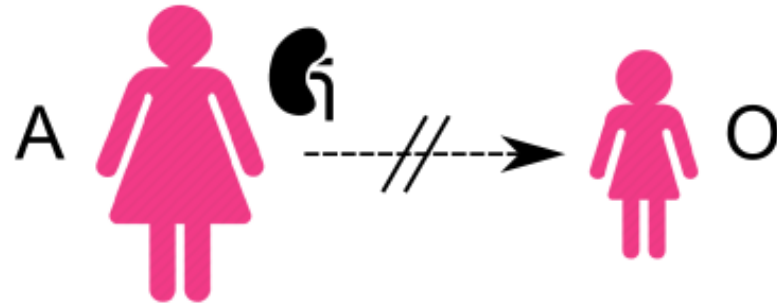

Kidney Exchange

Simply having a willing donor is not enough.
The organ must be **medically compatible**.

Blood-type incompatibility

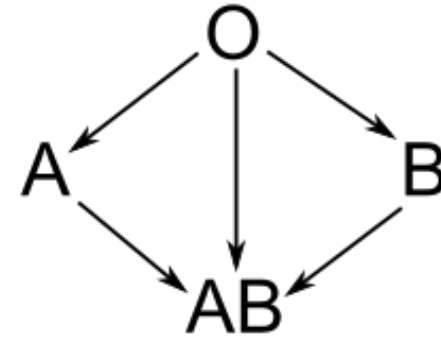
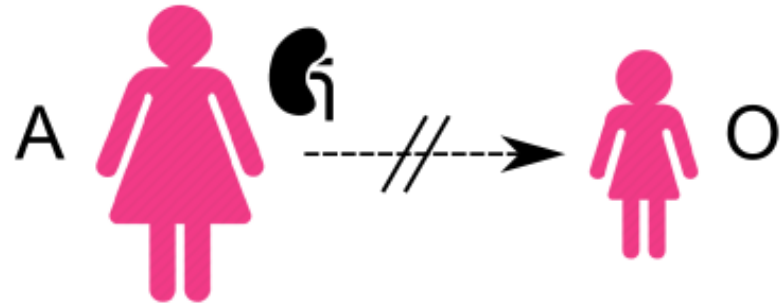

Tissue-type incompatibility

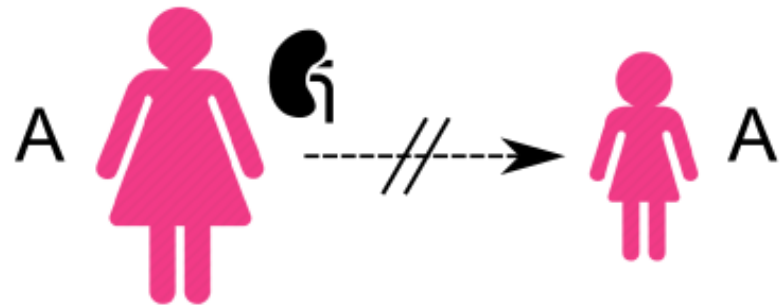

Sensitized patients with antibodies that will attack a foreign tissue (often due to prior exposure during blood transfusion, pregnancy, previous transplants).

Kidney Exchange

[Rapaport, *Transpl. Proc.* 1986; Ross et al. *NEJM* 1997]

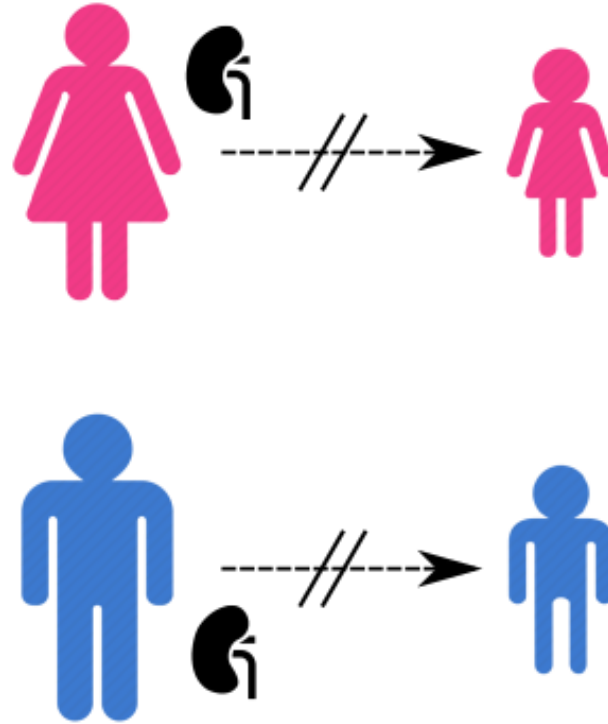

Kidney Exchange

[Rapaport, *Transpl. Proc.* 1986; Ross et al. *NEJM* 1997]

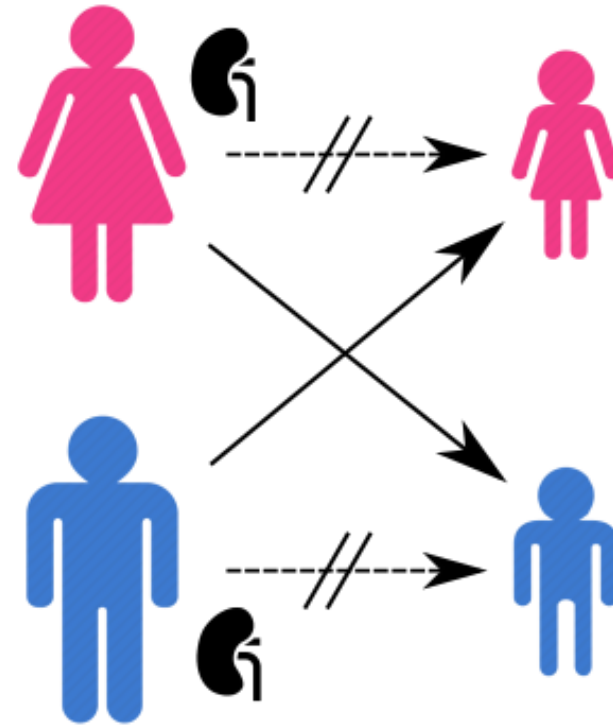

Kidney Exchange

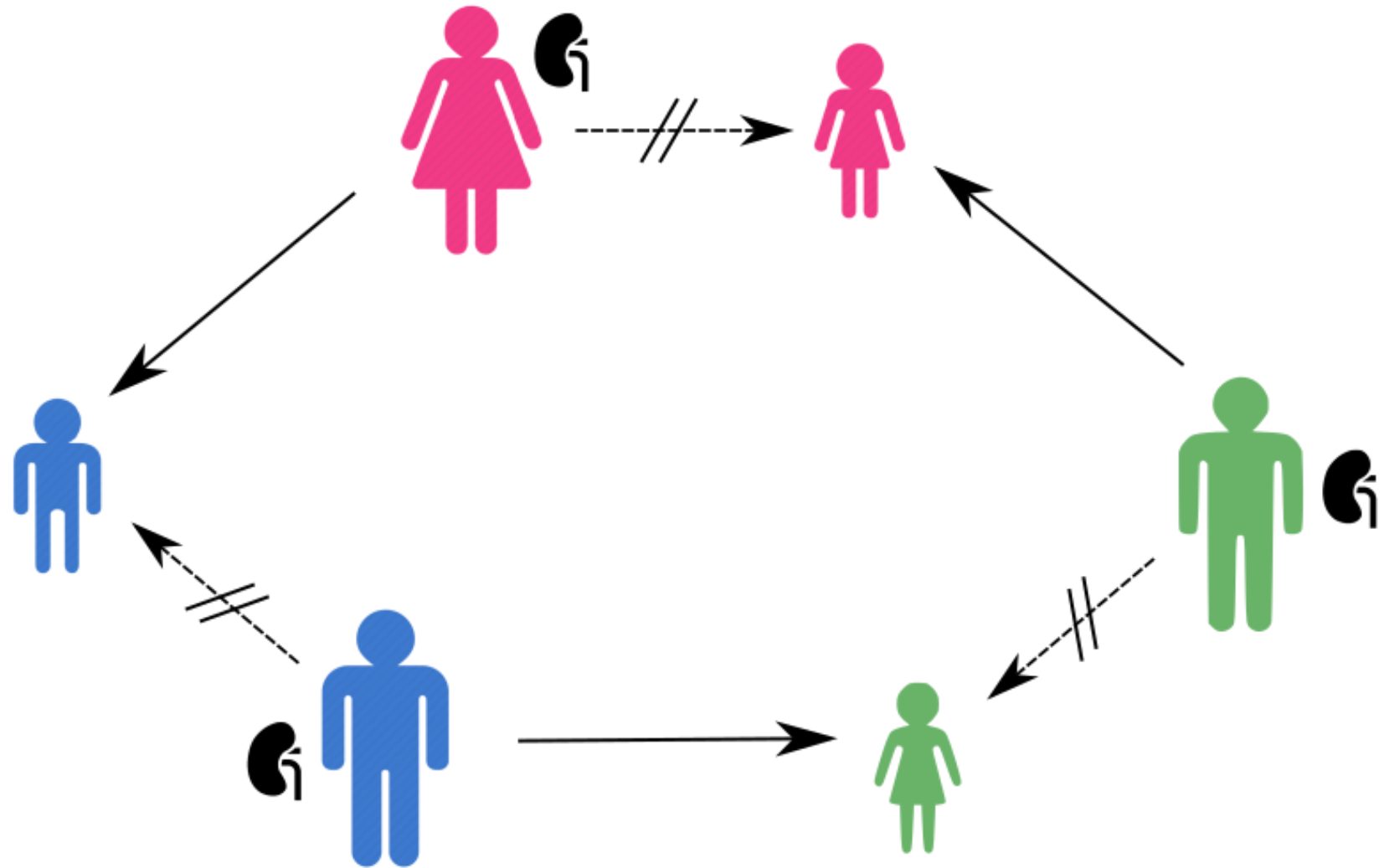

Kidney Exchange

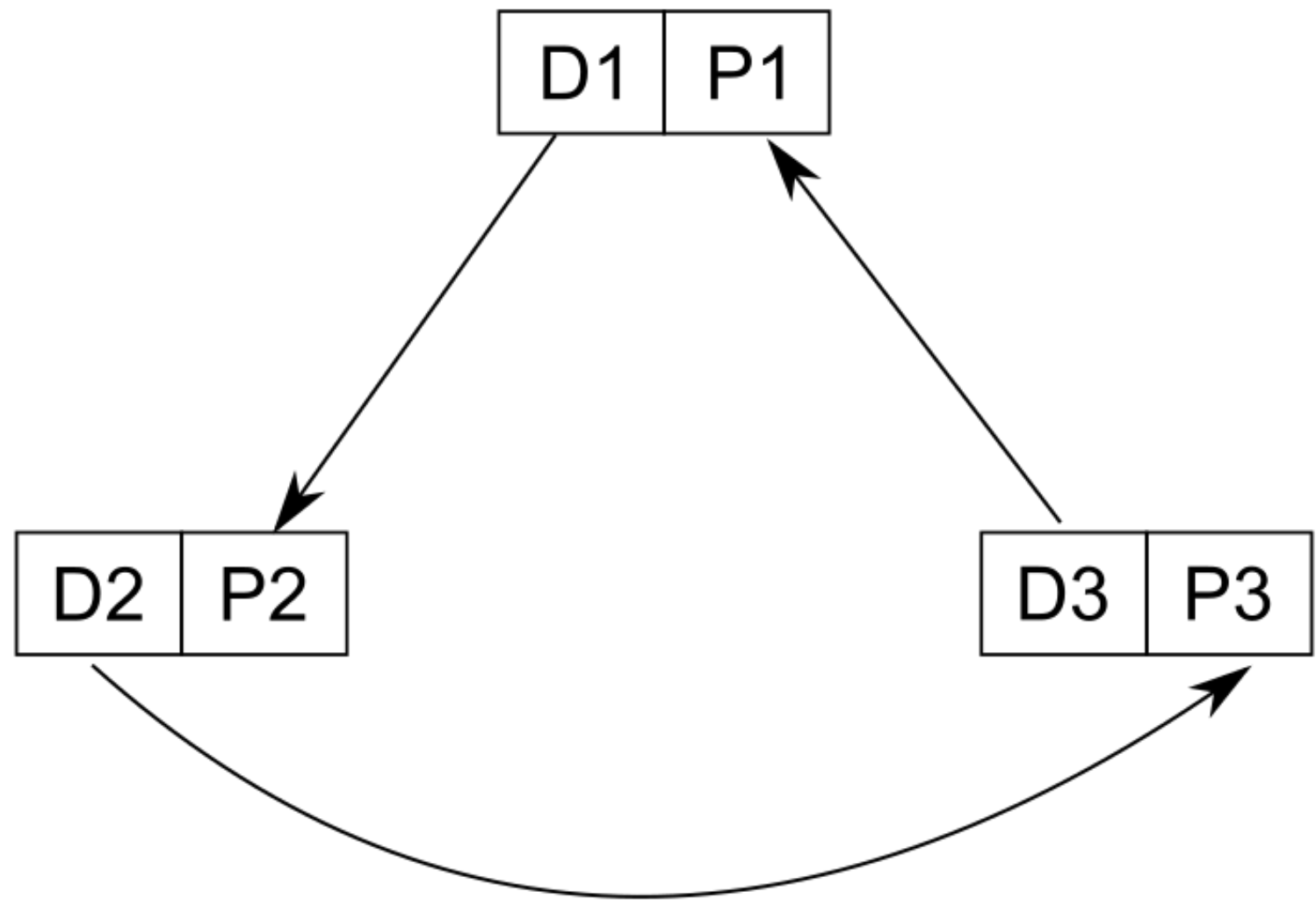

Kidney Exchange

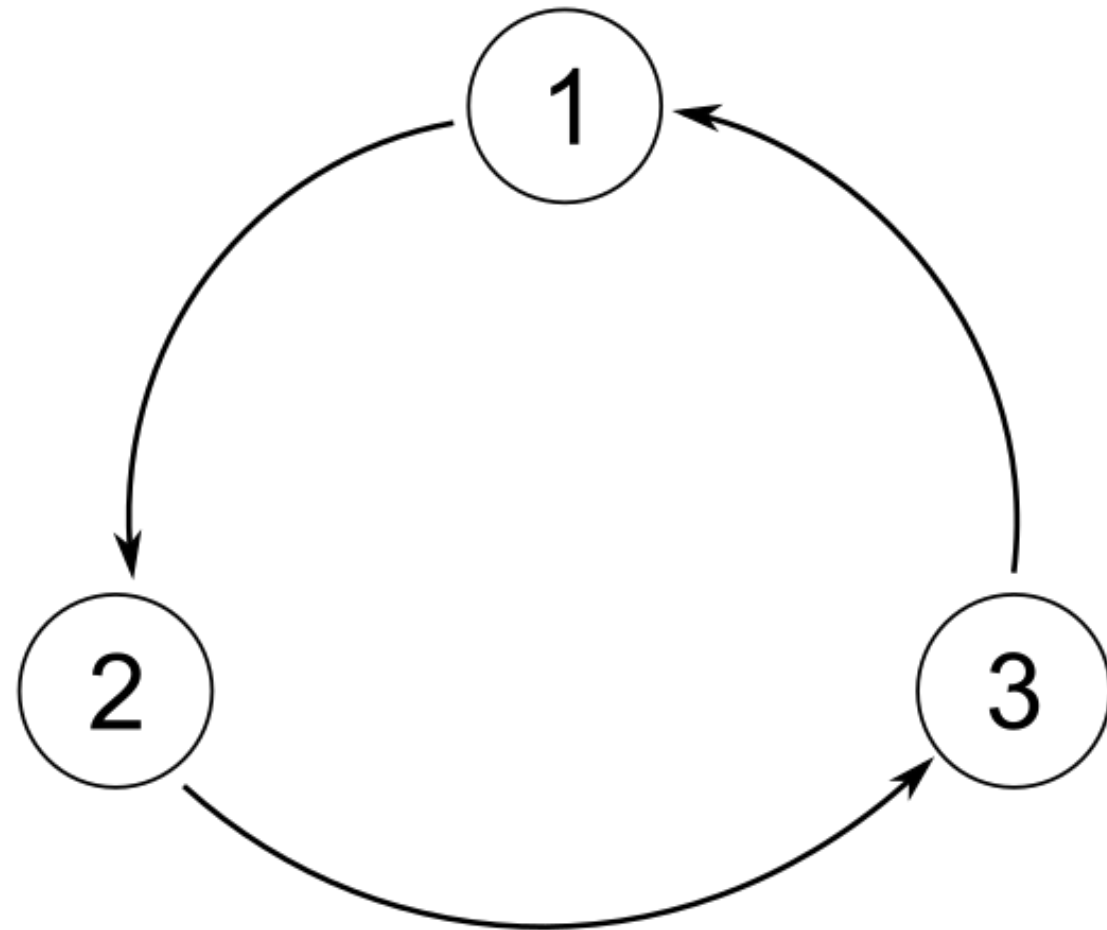
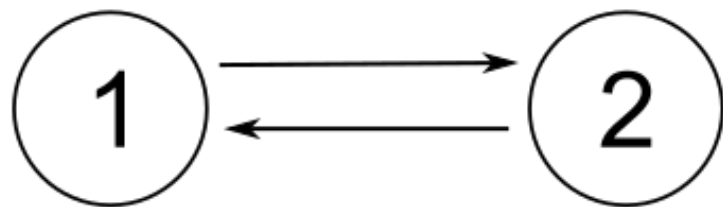

Kidney Exchange

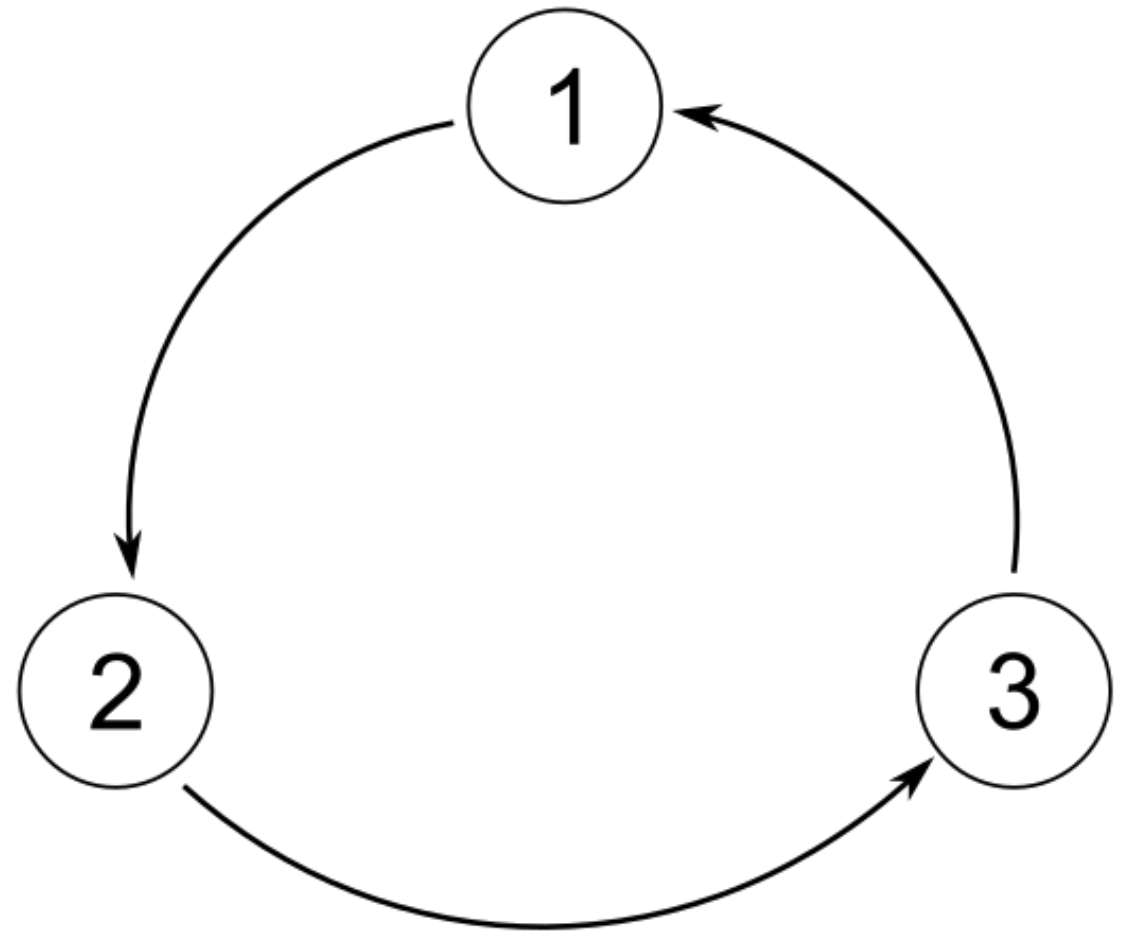
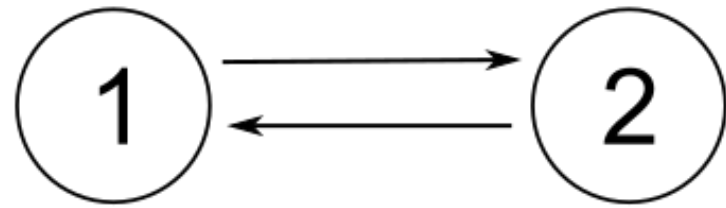

Intuitively, having more and more of such willing-but-incompatible pairs will create more opportunities for an exchange.

History [\[edit \]](#)

Year	Event
1986	KPD first suggested by Rapaport ^[14]
1991	First KPD program started in South Korea by Dr. Park ^[8]
1999	First European KPD transplants performed in Switzerland ^[8]
2000	First KPD transplants performed in USA at the Rhode Island Hospital ^[8]
2001	Hopkins completes KPD transplants and begins first KPD program in USA ^[15]
2004	Dutch established first national KPD program ^[8]
2007	NEAD chain started by APD utilizing first bridge donor ^[16]
2007	Charlie Norwood Living Organ Donation Act clarifies legality of KPD in USA ^[17]
2008	National Kidney Registry organizes its first transplants on Valentine's Day ^[18]
2009	Hopkins leads first 16 patient multicenter Domino Chain ^{[19][20]}
2010	UNOS organizes its first KPD transplants ^[8]
2012	National Kidney Registry completes largest chain involving 60 participants ^[6]
2014	National Kidney Registry sets new record with 70 participant chain ^[7]
2017	First Academic Paper published on "Chronological Incompatibility" outlining the ADP Voucher Program" ^[21]

History [\[edit \]](#)

Year	Event
1986	KPD first suggested by Rapaport ^[14]
1991	First KPD program started in South Korea by Dr. Park ^[8]
1999	First European KPD transplants performed in Switzerland ^[8]
2000	First KPD transplants performed in USA at the Rhode Island Hospital ^[8]
2001	Hopkins completes KPD transplants and begins first KPD program in USA ^[15]
2004	Dutch established first national KPD program ^[8]
2007	NEAD chain started by APD utilizing first bridge donor ^[16]
2007	Charlie Norwood Living Organ Donation Act clarifies legality of KPD in USA ^[17]
2008	National Kidney Registry organizes its first transplants on Valentine's Day ^[18]
2009	Hopkins leads first 16 patient multicenter Domino Chain ^{[19][20]}
2010	UNOS organizes its first KPD transplants ^[8]
2012	National Kidney Registry completes largest chain involving 60 participants ^[6]
2014	National Kidney Registry sets new record with 70 participant chain ^[7]
2017	First Academic Paper published on "Chronological Incompatibility" outlining the ADP Voucher Program" ^[21]

Early Proposals for Kidney Exchange

Proposal 1

Using TTCA



Proposal 2



Proposal 1: Kidney Exchange using TTCA

[Roth, Sönmez, and Ünver, *QJE* 2004]

Proposal 1: Kidney Exchange using TTCA

[Roth, Sönmez, and Ünver, *QJE* 2004]

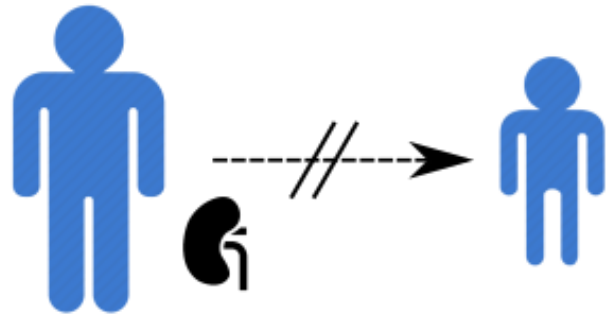
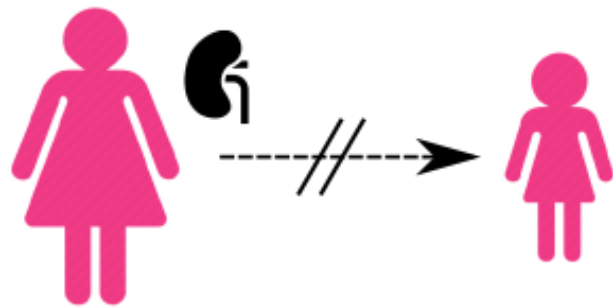

Proposal 1: Kidney Exchange using TTCA

[Roth, Sönmez, and Ünver, *QJE* 2004]

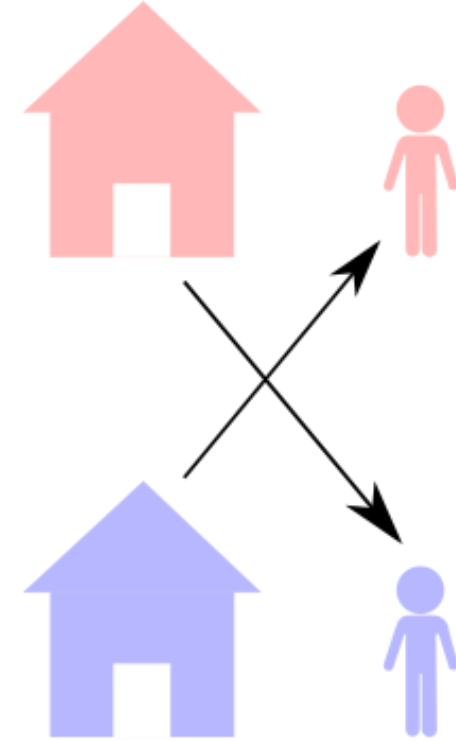
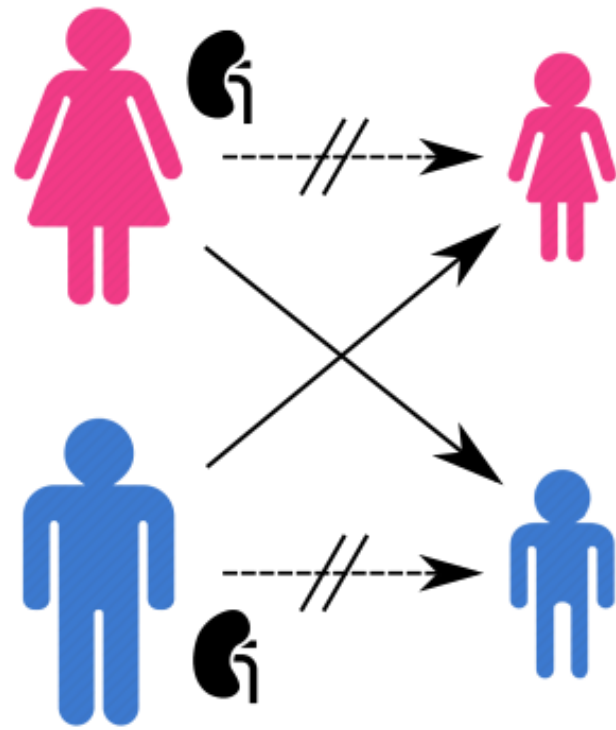

Proposal 1: Kidney Exchange using TTCA

[Roth, Sönmez, and Ünver, *QJE* 2004]

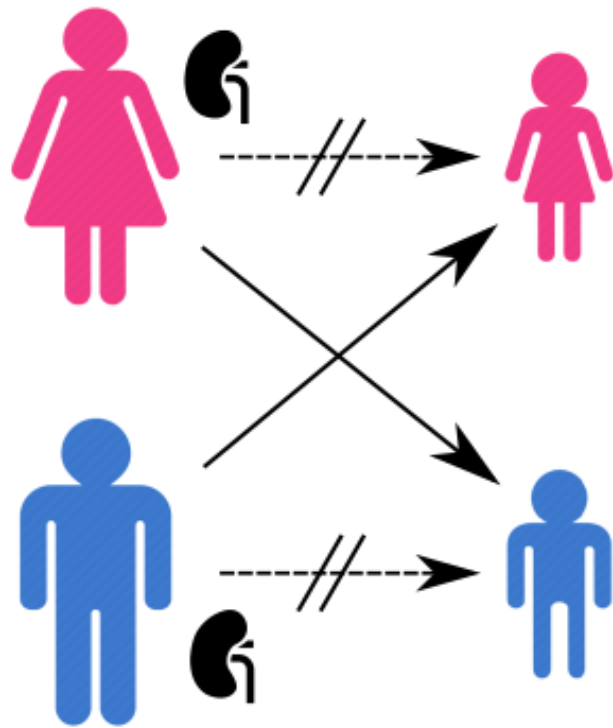

Each patient has a strict ranking of donors.

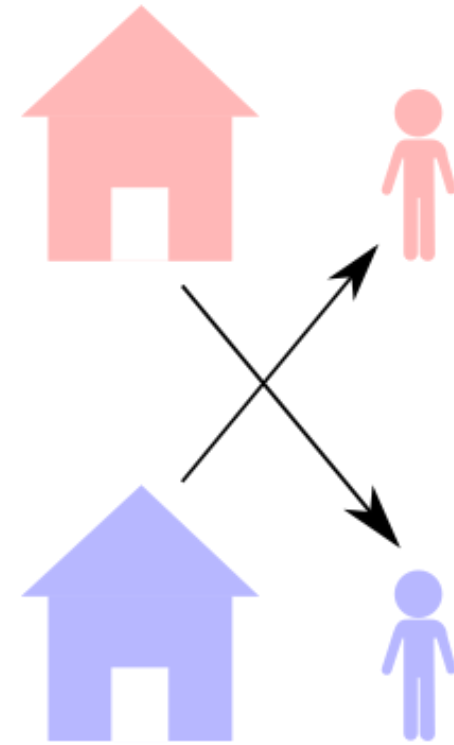

Each agent has a strict ranking of houses.

Proposal 1: Kidney Exchange using TTCA

[Roth, Sönmez, and Ünver, *QJE* 2004]

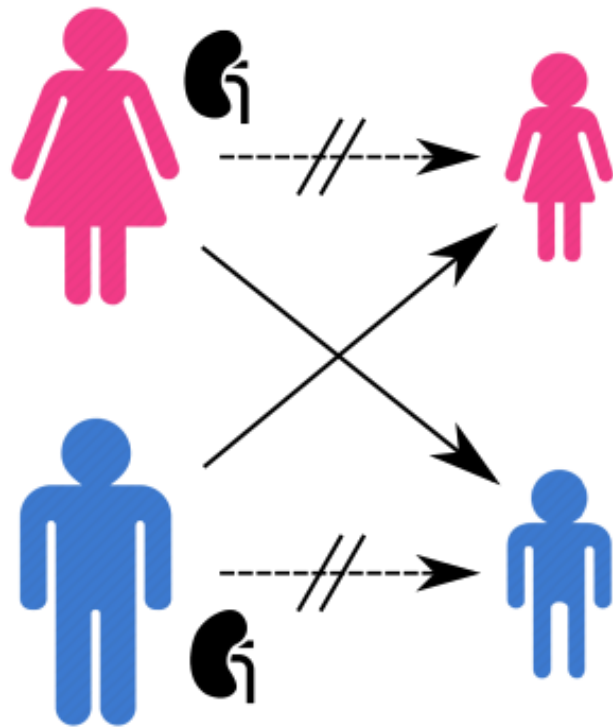

Each patient has a
strict ranking of donors.
(medically determined)

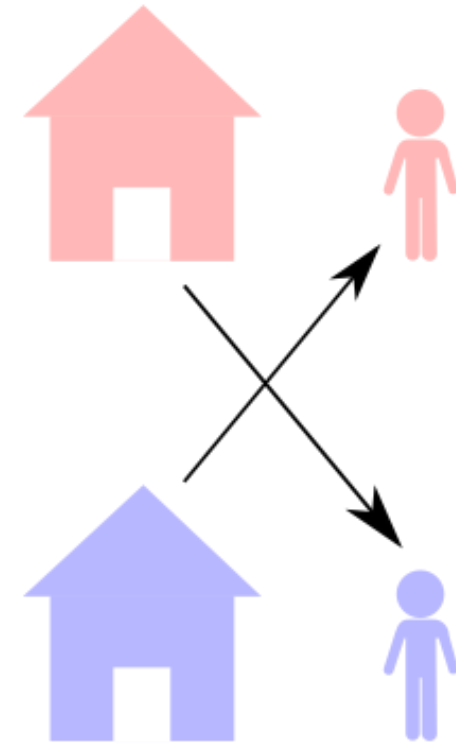

Each agent has a
strict ranking of houses.
(idiosyncratic)

Advantages of Kidney Exchange using TTCA

Advantages of Kidney Exchange using TTCA



No group of patients can strictly improve by reallocating donors among themselves.



Every patient is (weakly) better off than before.



Polynomial time.

Limitations of Kidney Exchange using TTCA

Limitations of Kidney Exchange using TTCA

In practice, there may be:



- patients without a donor ("agents without a house")
- deceased donors ("house without an owner").

Limitations of Kidney Exchange using TTCA

In practice, there may be:



- patients without a donor ("agents without a house")
- deceased donors ("house without an owner").

"You request my house---I get your turn" [Abdulkadiroğlu and Sönmez, JET 1999]

Limitations of Kidney Exchange using TTCA

In practice, there may be:



- patients without a donor ("agents without a house")
- deceased donors ("house without an owner").

"You request my house---I get your turn" [Abdulkadiroğlu and Sönmez, JET 1999]



Limitations of Kidney Exchange using TTCA

In practice, there may be:



- patients without a donor ("agents without a house")
- deceased donors ("house without an owner").

"You request my house---I get your turn" [Abdulkadiroğlu and Sönmez, JET 1999]



Limitations of Kidney Exchange using TTCA

In practice, there may be:



- patients without a donor ("agents without a house")
- deceased donors ("house without an owner").

"You request my house---I get your turn" [Abdulkadiroğlu and Sönmez, JET 1999]



3

4



2



1

5



Limitations of Kidney Exchange using TTCA

In practice, there may be:



- patients without a donor ("agents without a house")
- deceased donors ("house without an owner").

"You request my house---I get your turn" [Abdulkadiroğlu and Sönmez, JET 1999]



Limitations of Kidney Exchange using TTCA

In practice, there may be:



- patients without a donor ("agents without a house")
- deceased donors ("house without an owner").

"You request my house---I get your turn" [Abdulkadiroğlu and Sönmez, JET 1999]



Limitations of Kidney Exchange using TTCA

In practice, there may be:



- patients without a donor ("agents without a house")
- deceased donors ("house without an owner").

"You request my house---I get your turn" [Abdulkadiroğlu and Sönmez, JET 1999]



Limitations of Kidney Exchange using TTCA

In practice, there may be:



- patients without a donor ("agents without a house")
- deceased donors ("house without an owner").

"You request my house---I get your turn" [Abdulkadiroğlu and Sönmez, JET 1999]

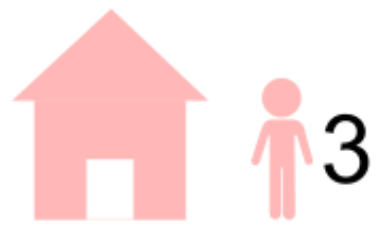

Limitations of Kidney Exchange using TTCA

In practice, there may be:



- patients without a donor ("agents without a house")
- deceased donors ("house without an owner").

"You request my house---I get your turn" [Abdulkadiroğlu and Sönmez, JET 1999]



Limitations of Kidney Exchange using TTCA

In practice, there may be:



- patients without a donor ("agents without a house")
- deceased donors ("house without an owner").

"You request my house---I get your turn" [Abdulkadiroğlu and Sönmez, JET 1999]



Limitations of Kidney Exchange using TTCA

In practice, there may be:



- patients without a donor ("agents without a house")
- deceased donors ("house without an owner").

"You request my house---I get your turn" [Abdulkadiroğlu and Sönmez, JET 1999]



Limitations of Kidney Exchange using TTCA

In practice, there may be:



- patients without a donor ("agents without a house")
- deceased donors ("house without an owner").

"You request my house---I get your turn" [Abdulkadiroğlu and Sönmez, JET 1999]



Limitations of Kidney Exchange using TTCA

In practice, there may be:



- patients without a donor ("agents without a house")
- deceased donors ("house without an owner").

"You request my house---I get your turn" [Abdulkadiroğlu and Sönmez, JET 1999]



Limitations of Kidney Exchange using TTCA

In practice, there may be:



- patients without a donor ("agents without a house")
- deceased donors ("house without an owner").

"You request my house---I get your turn" [Abdulkadiroğlu and Sönmez, JET 1999]



Limitations of Kidney Exchange using TTCA

In practice, there may be:



- patients without a donor ("agents without a house")
- deceased donors ("house without an owner").

"You request my house---I get your turn" [Abdulkadiroğlu and Sönmez, JET 1999]

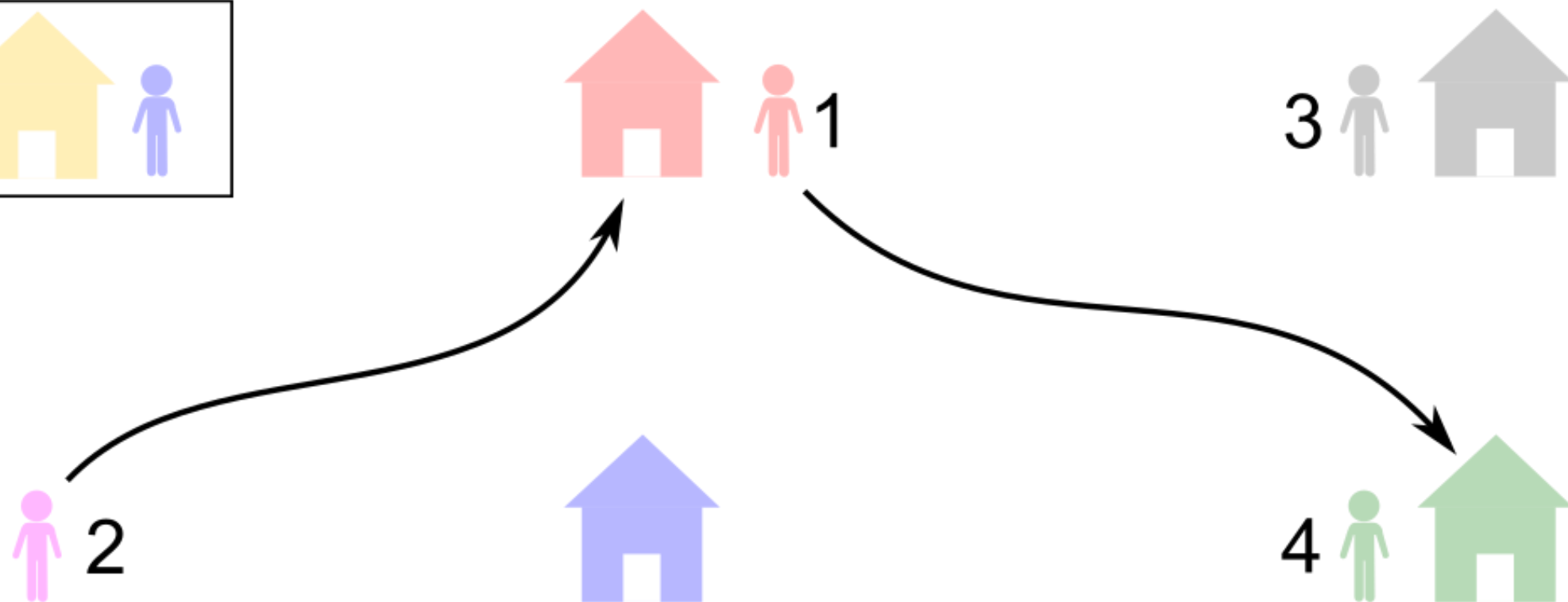

Limitations of Kidney Exchange using TTCA

In practice, there may be:



- patients without a donor ("agents without a house")
- deceased donors ("house without an owner").

"You request my house---I get your turn" [Abdulkadiroğlu and Sönmez, JET 1999]

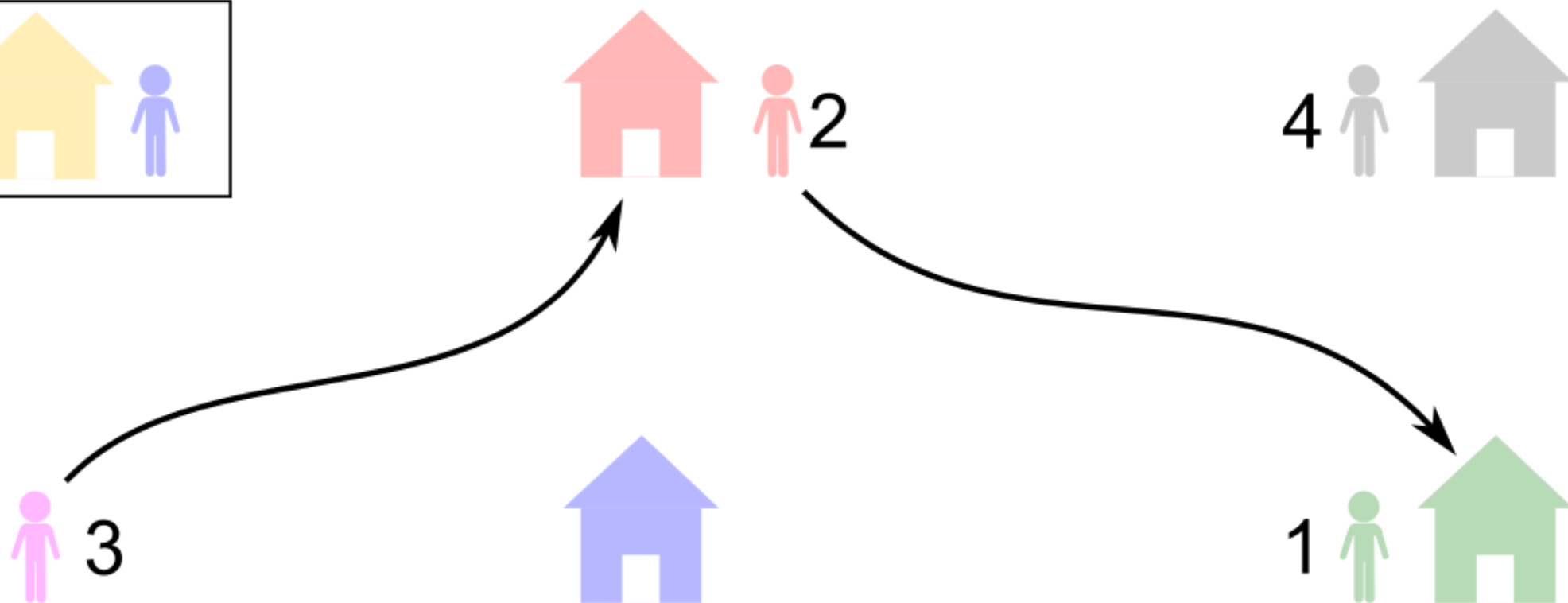
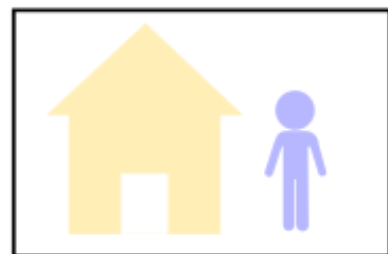

Limitations of Kidney Exchange using TTCA

In practice, there may be:



- patients without a donor ("agents without a house")
- deceased donors ("house without an owner").

"You request my house---I get your turn" [Abdulkadiroğlu and Sönmez, JET 1999]

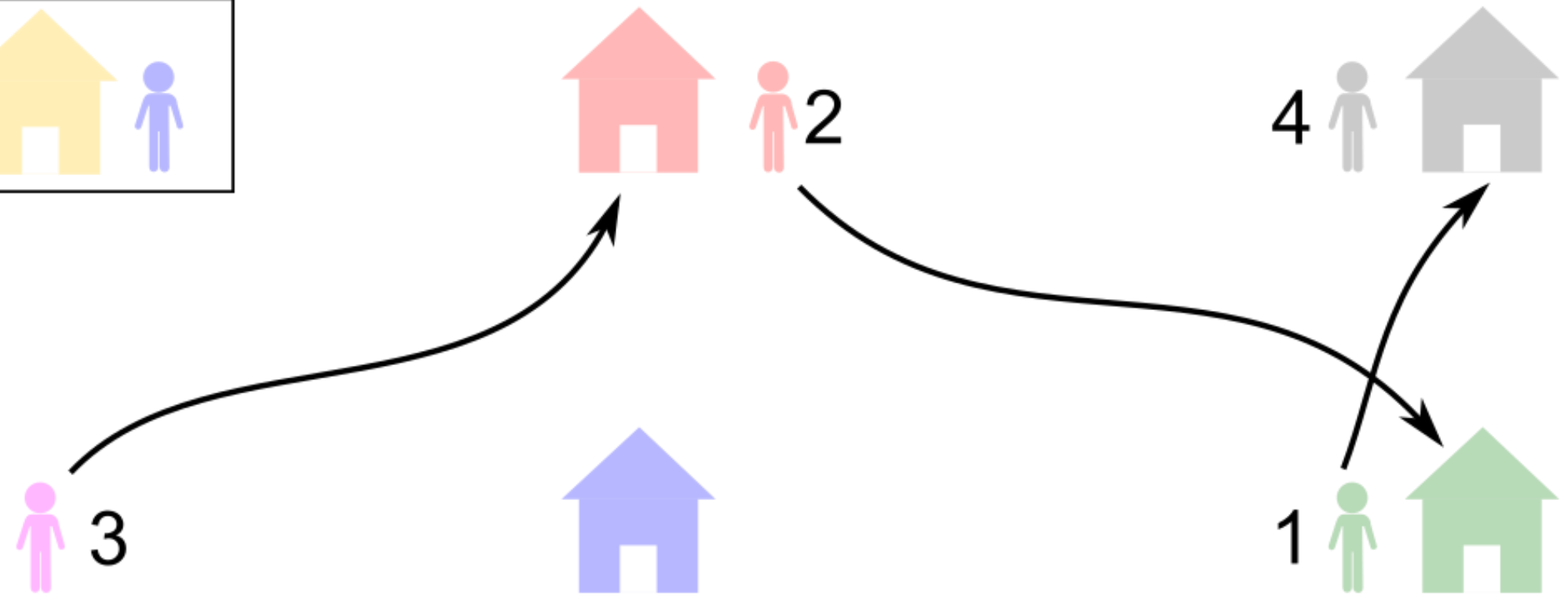

Limitations of Kidney Exchange using TTCA

In practice, there may be:



- patients without a donor ("agents without a house")
- deceased donors ("house without an owner").

"You request my house---I get your turn" [Abdulkadiroğlu and Sönmez, JET 1999]

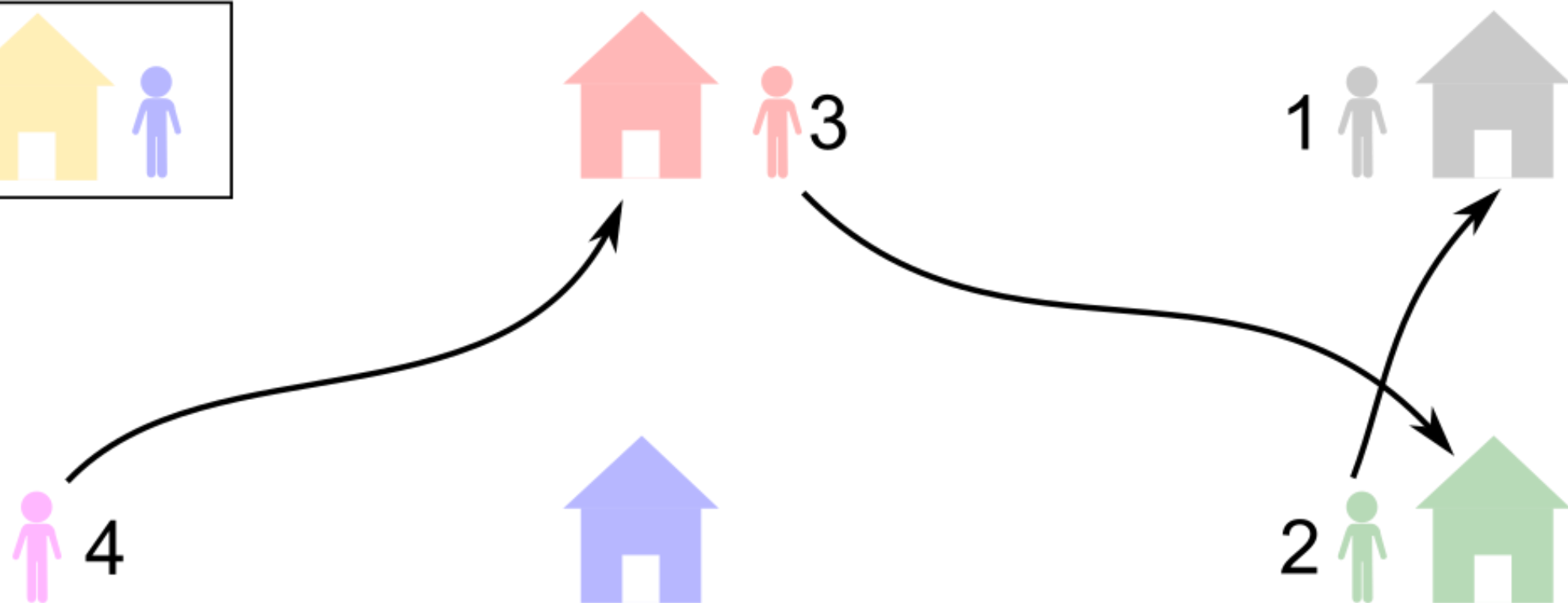

Limitations of Kidney Exchange using TTCA

In practice, there may be:



- patients without a donor ("agents without a house")
- deceased donors ("house without an owner").

"You request my house---I get your turn" [Abdulkadiroğlu and Sönmez, JET 1999]

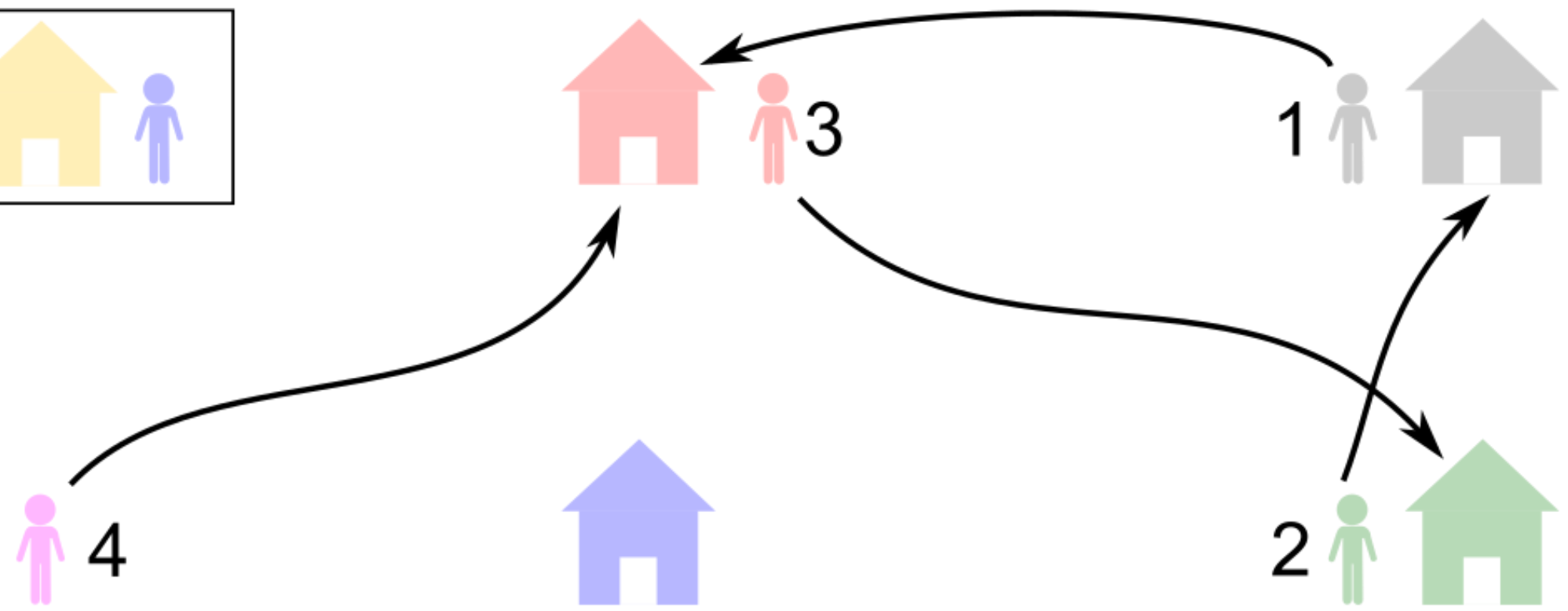

Limitations of Kidney Exchange using TTCA

In practice, there may be:



- patients without a donor ("agents without a house")
- deceased donors ("house without an owner").

"You request my house---I get your turn" [Abdulkadiroğlu and Sönmez, JET 1999]

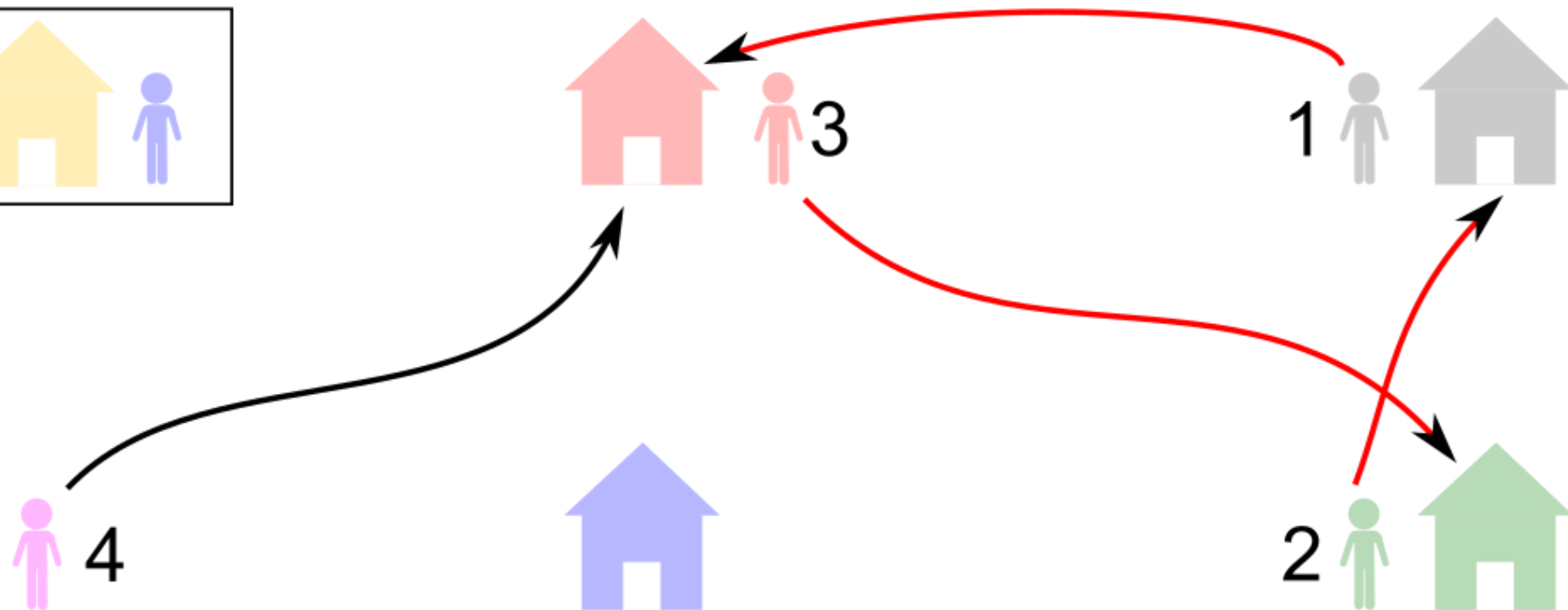

Limitations of Kidney Exchange using TTCA

In practice, there may be:



- patients without a donor ("agents without a house")
- deceased donors ("house without an owner").

"You request my house---I get your turn" [Abdulkadiroğlu and Sönmez, JET 1999]

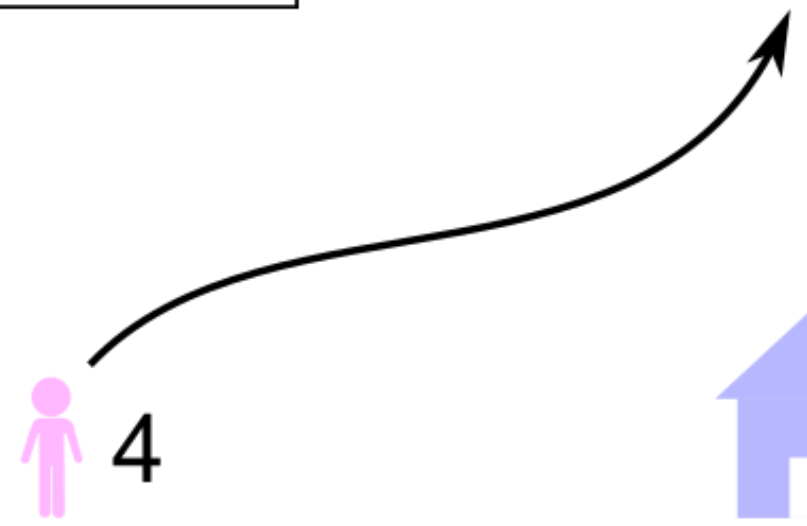

Limitations of Kidney Exchange using TTCA

In practice, there may be:



- patients without a donor ("agents without a house")
- deceased donors ("house without an owner").

"You request my house---I get your turn" [Abdulkadiroğlu and Sönmez, JET 1999]

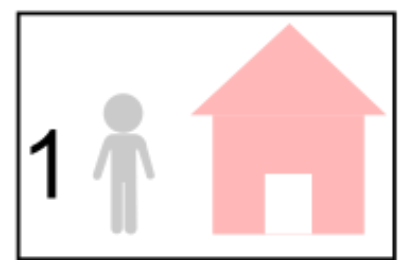
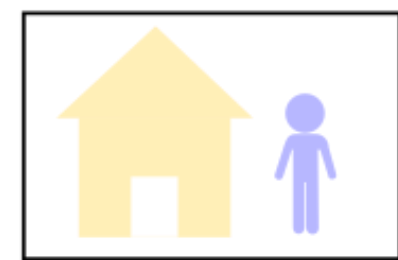

Limitations of Kidney Exchange using TTCA

In practice, there may be:



- patients without a donor ("agents without a house")
- deceased donors ("house without an owner").

"You request my house---I get your turn" [Abdulkadiroğlu and Sönmez, JET 1999]



Limitations of Kidney Exchange using TTCA

In practice, there may be:



- patients without a donor ("agents without a house")
- deceased donors ("house without an owner").

"You request my house---I get your turn" [Abdulkadiroğlu and Sönmez, JET 1999]

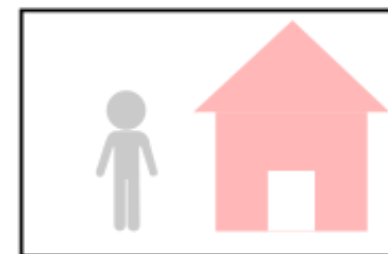

Limitations of Kidney Exchange using TTCA

In practice, there may be:



- patients without a donor ("agents without a house")
- deceased donors ("house without an owner").

"You request my house---I get your turn" [Abdulkadiroğlu and Sönmez, JET 1999]



Limitations of Kidney Exchange using TTCA

Limitations of Kidney Exchange using TTCA



Long cycles can lead to **logistical problems**.

Limitations of Kidney Exchange using TTCA



Long cycles can lead to **logistical problems**.

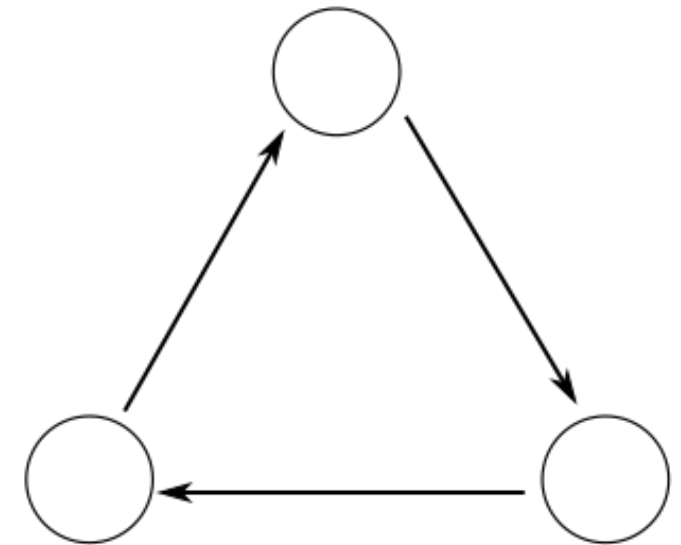
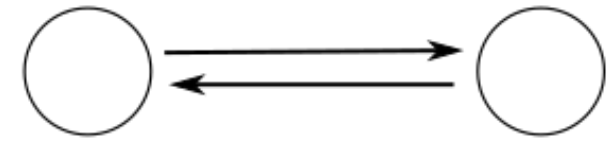
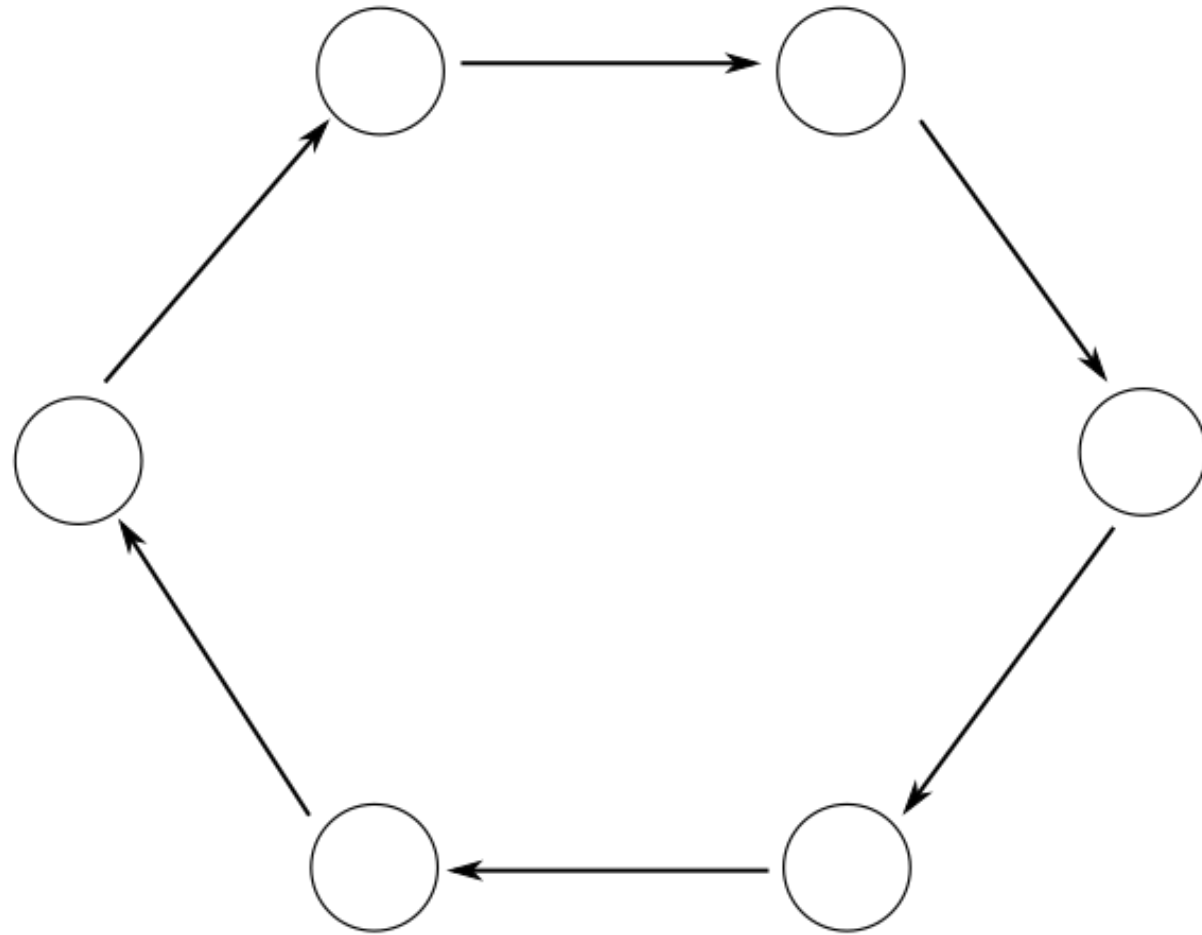

Limitations of Kidney Exchange using TTCA



Long cycles can lead to **logistical problems**.

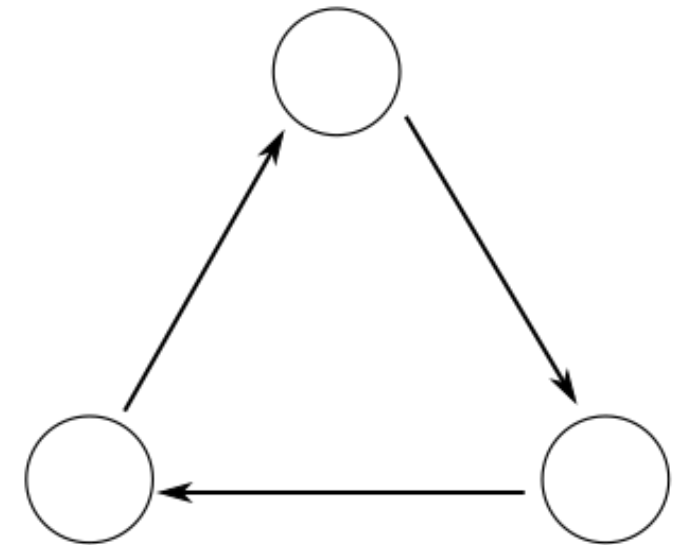
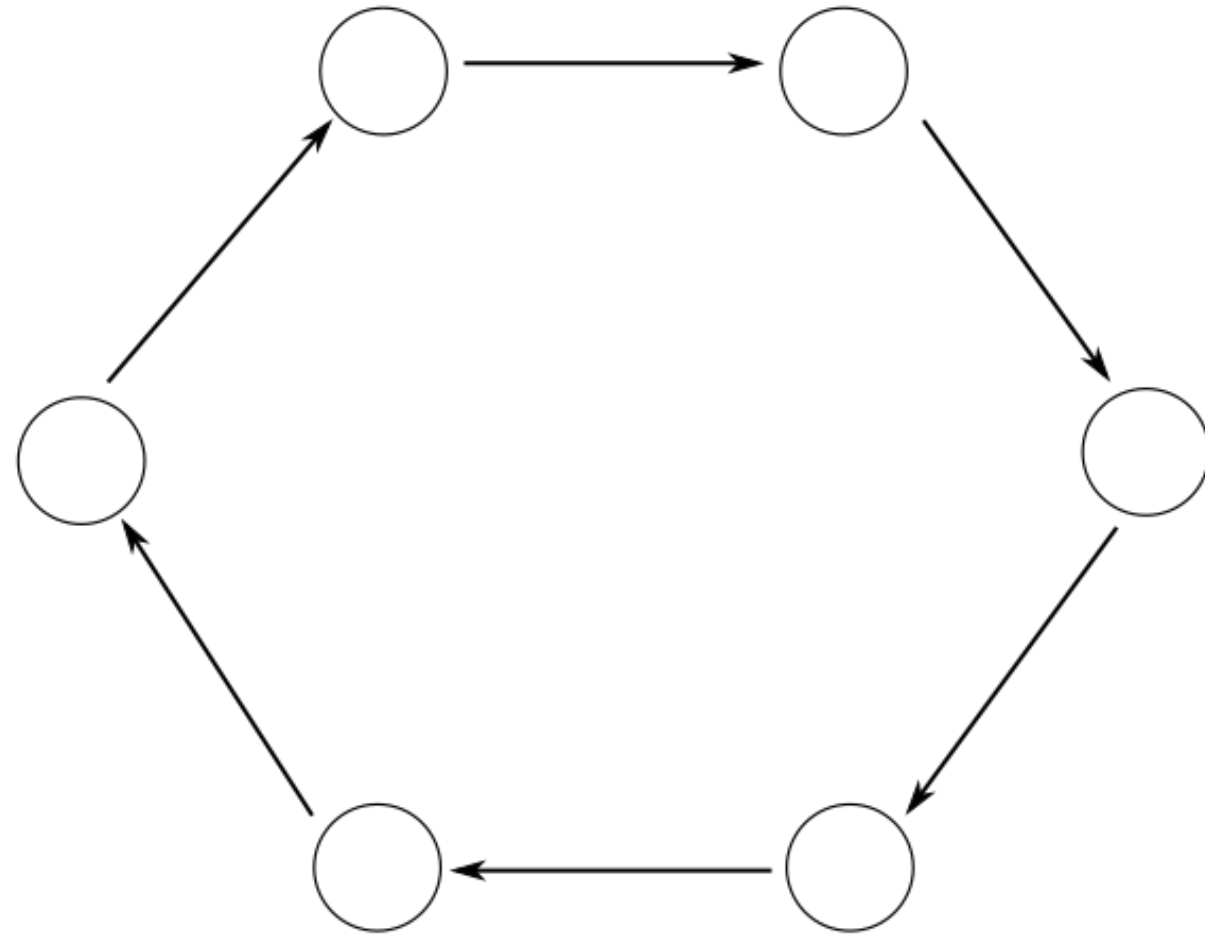

Limitations of Kidney Exchange using TTCA



Long cycles can lead to **logistical problems**.

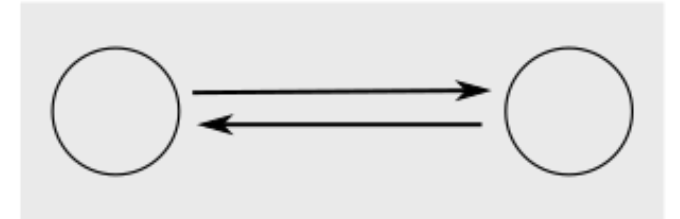

Limitations of Kidney Exchange using TTCA



Long cycles can lead to **logistical problems**.

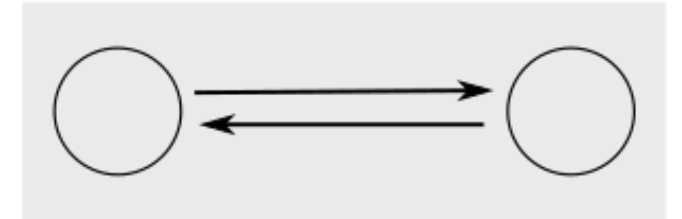
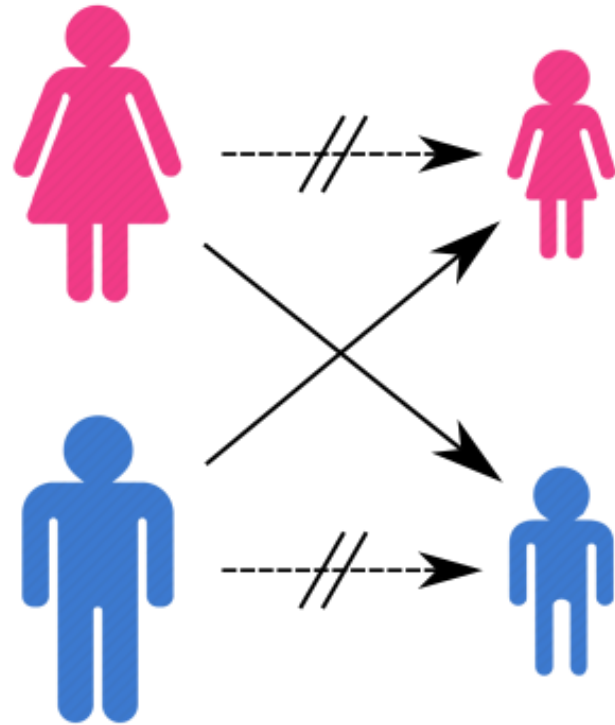

Limitations of Kidney Exchange using TTCA



Long cycles can lead to **logistical problems**.

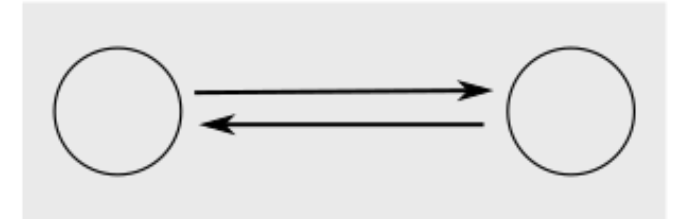
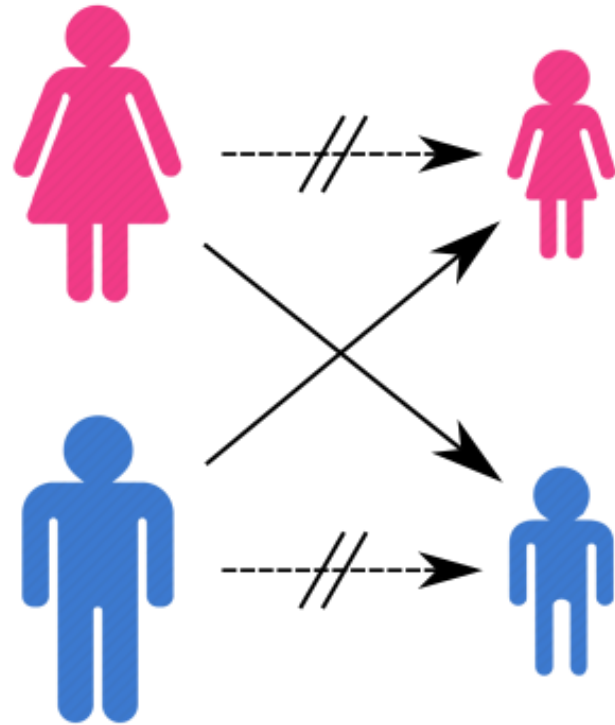

Four surgeries

Limitations of Kidney Exchange using TTCA



Long cycles can lead to **logistical problems**.

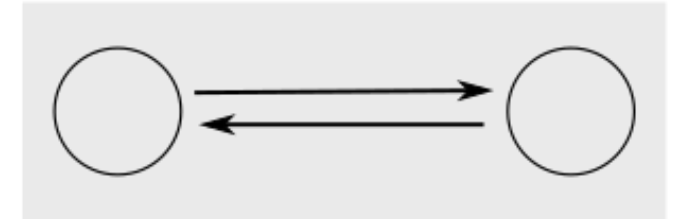
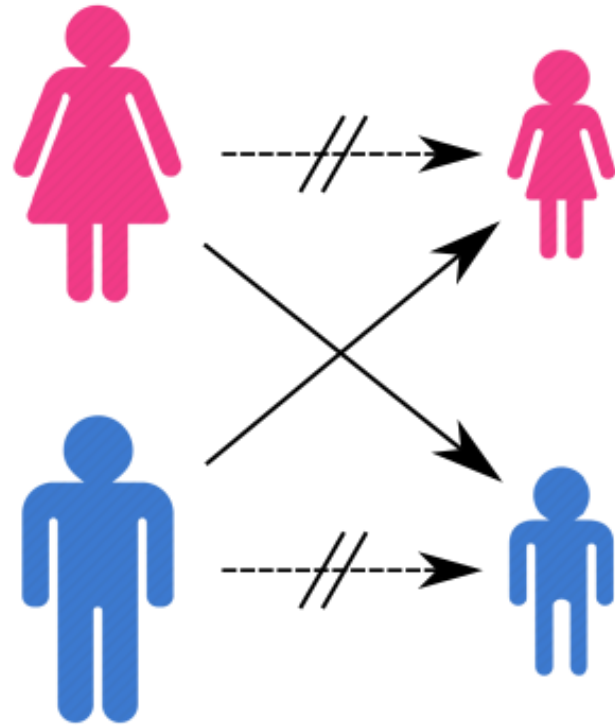

Four **simultaneous** surgeries

Limitations of Kidney Exchange using TTCA



Long cycles can lead to **logistical problems**.

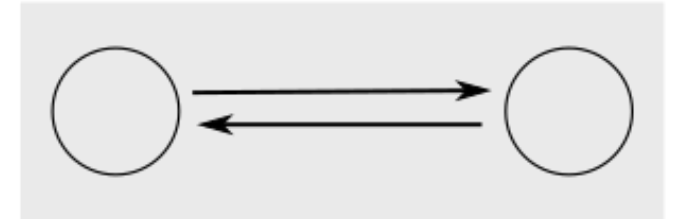
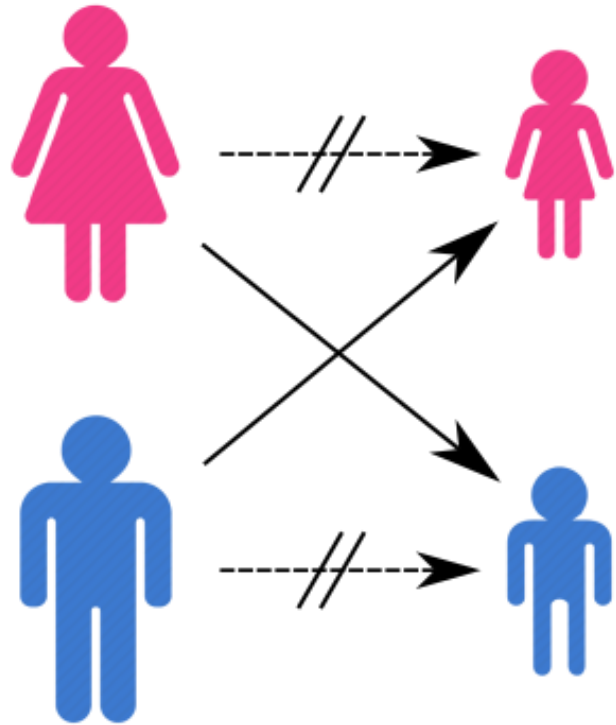

Four **simultaneous** surgeries

Cannot risk doing



Limitations of Kidney Exchange using TTCA



Long cycles can lead to **logistical problems**.

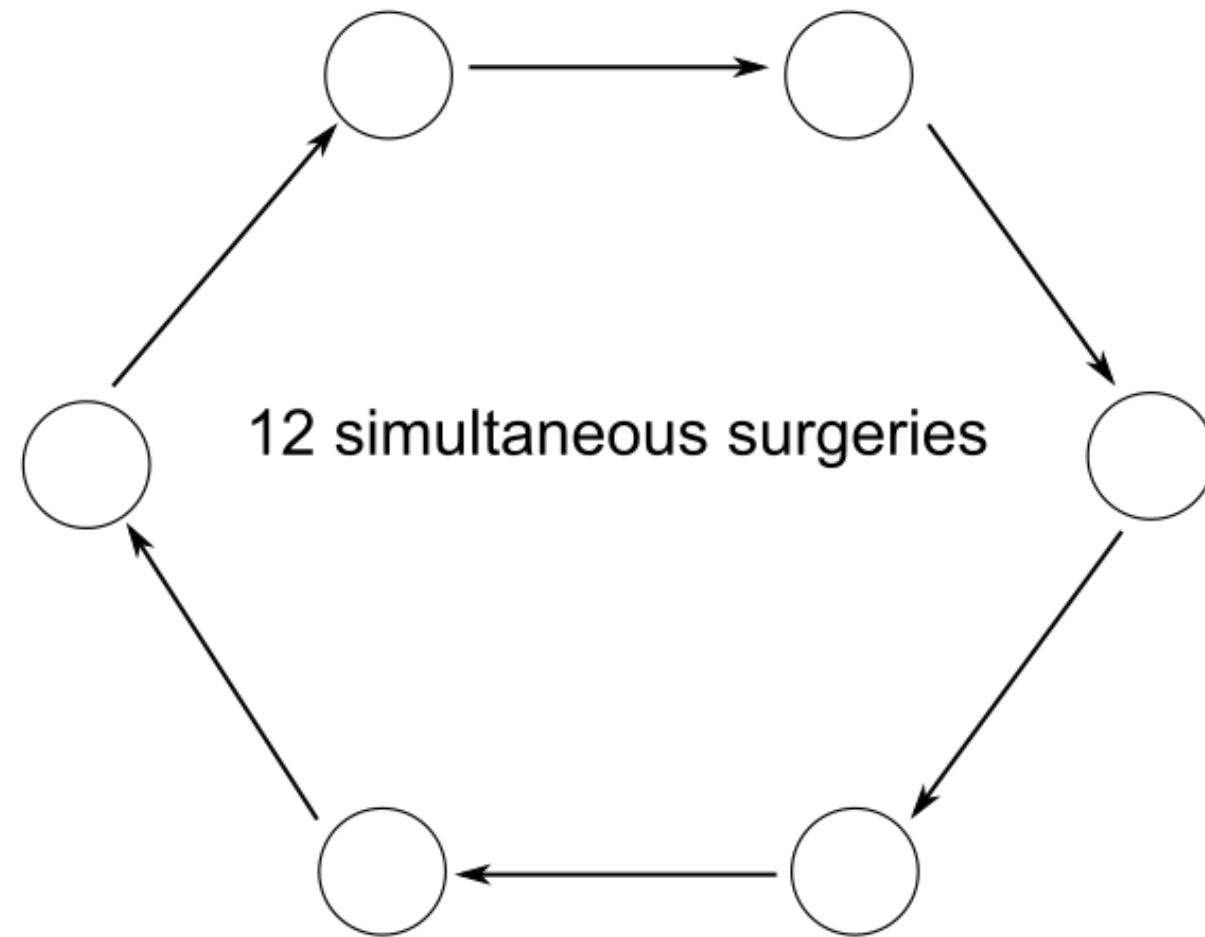

4 simultaneous surgeries

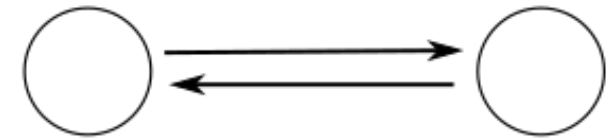

6 simultaneous surgeries

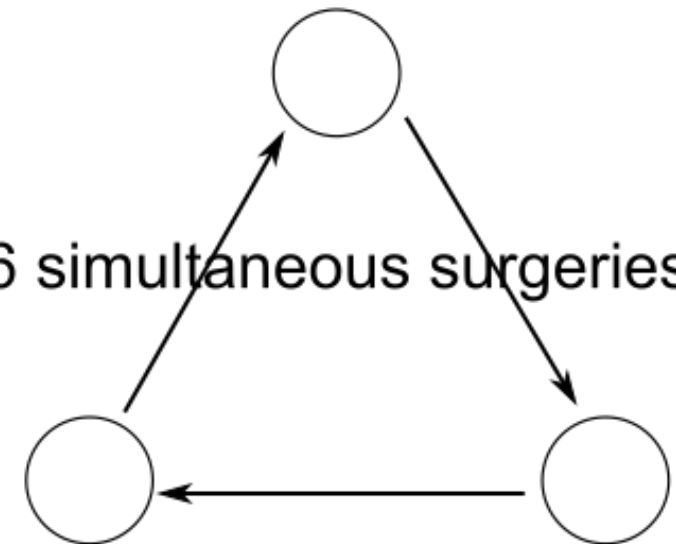

Limitations of Kidney Exchange using TTCA

Limitations of Kidney Exchange using TTCA



Strict preferences might be an overkill.

Binary preferences (compatible or incompatible) often suffice.

Limitations of Kidney Exchange using TTCA



Strict preferences might be an overkill.

Binary preferences (compatible or incompatible) often suffice.

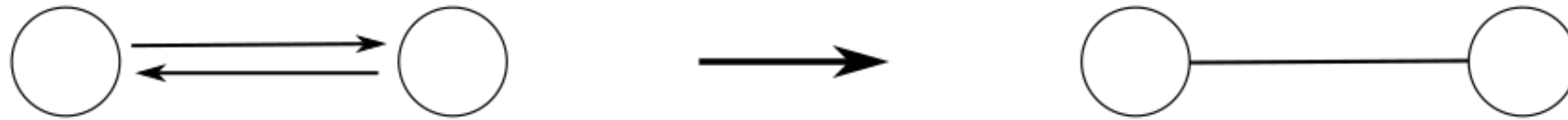

Early Proposals for Kidney Exchange

Proposal 1

Using TTCA



Proposal 2



Early Proposals for Kidney Exchange

Proposal 1

Using TTCA



Proposal 2

Using Matchings

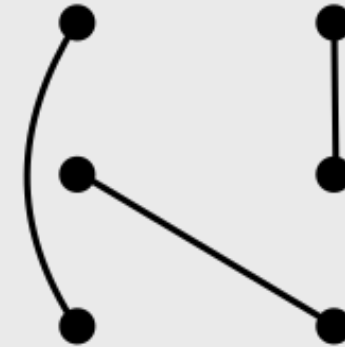

Proposal 2: Kidney Exchange using Matchings

[Roth, Sönmez, and Ünver, *JET* 2005]

Proposal 2: Kidney Exchange using Matchings

[Roth, Sönmez, and Ünver, *JET* 2005]

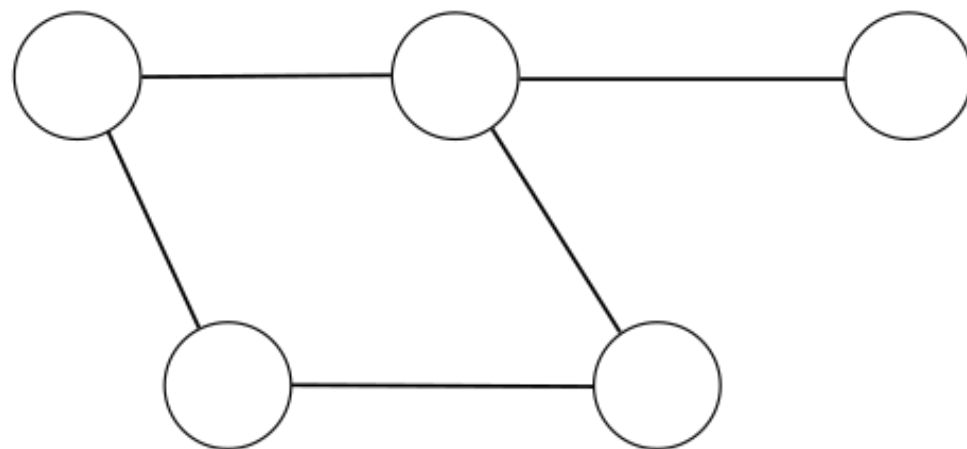

Proposal 2: Kidney Exchange using Matchings

[Roth, Sönmez, and Ünver, *JET* 2005]

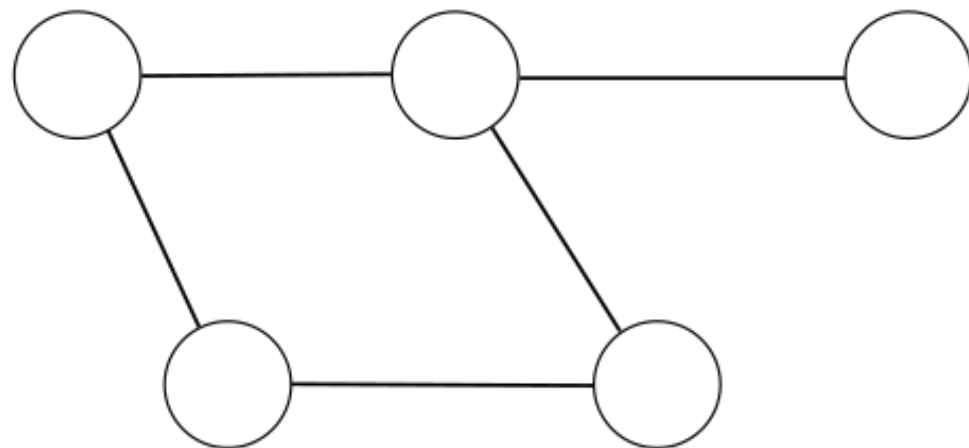

Given an undirected graph (of patient-donor pairs),
find a maximum cardinality matching.

Proposal 2: Kidney Exchange using Matchings

[Roth, Sönmez, and Ünver, *JET* 2005]

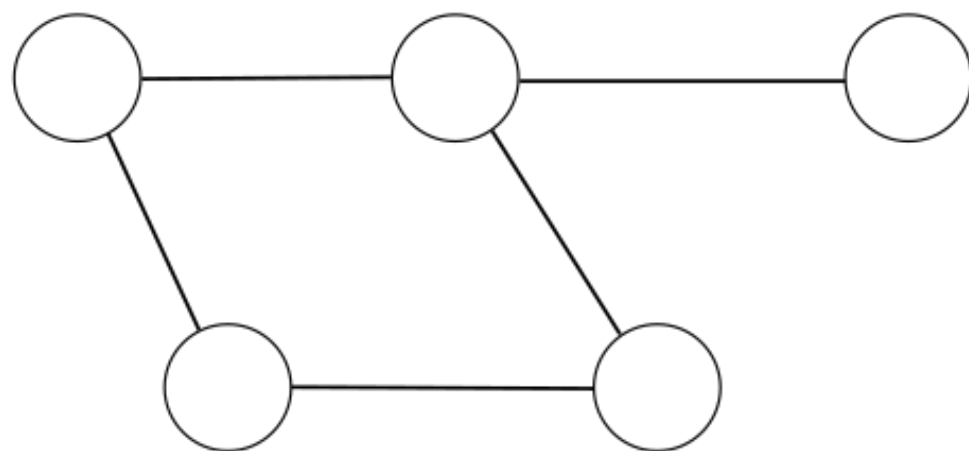

Given an undirected graph (of patient-donor pairs),
find **a** maximum cardinality matching.

underspecified (can lead to **incentive issues**)

Proposal 2: Kidney Exchange using Matchings

[Roth, Sönmez, and Ünver, *JET* 2005]

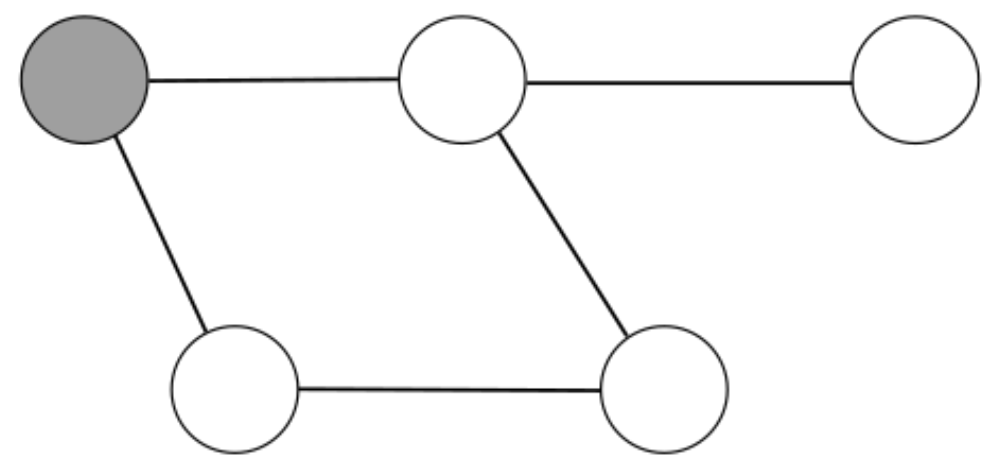

Given an undirected graph (of patient-donor pairs),
find **a** maximum cardinality matching.

↖ underspecified (can lead to **incentive issues**)

Proposal 2: Kidney Exchange using Matchings

[Roth, Sönmez, and Ünver, *JET* 2005]

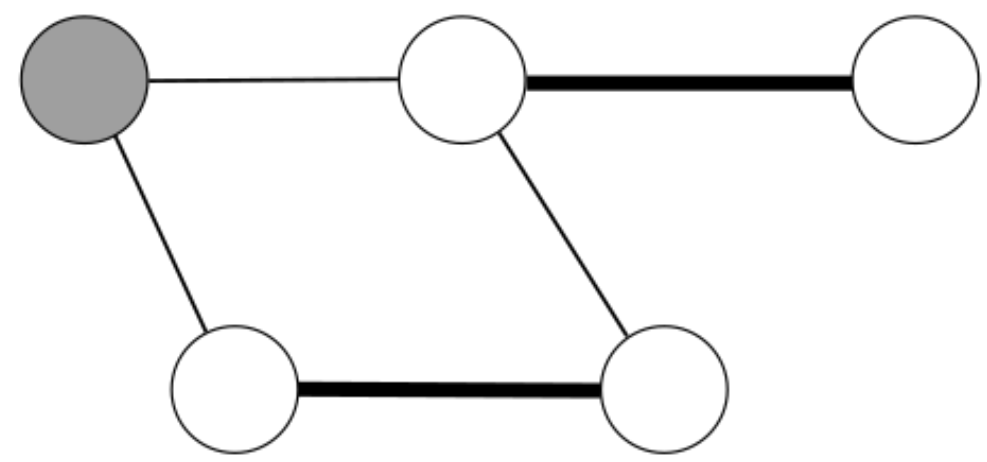

Given an undirected graph (of patient-donor pairs),
find **a** maximum cardinality matching.

↖ underspecified (can lead to **incentive issues**)

Proposal 2: Kidney Exchange using Matchings

[Roth, Sönmez, and Ünver, *JET* 2005]

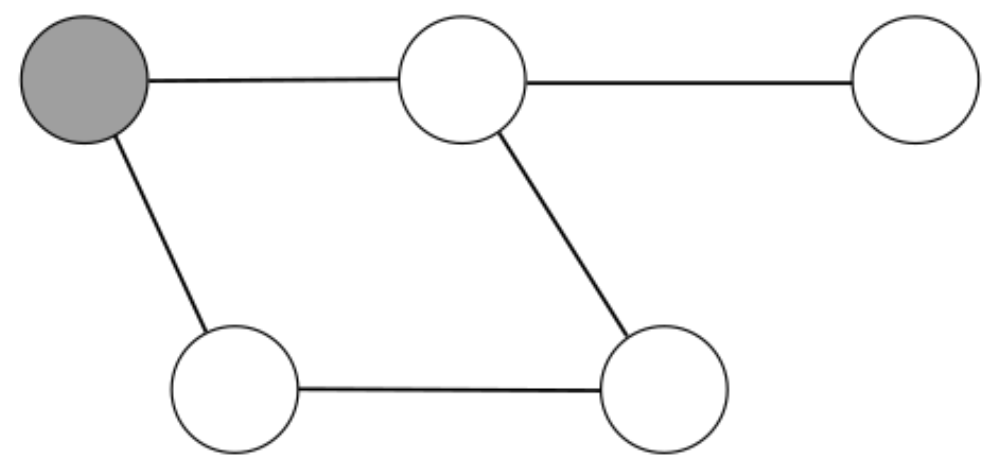

Given an undirected graph (of patient-donor pairs),
find **a** maximum cardinality matching.

↖ underspecified (can lead to **incentive issues**)

Proposal 2: Kidney Exchange using Matchings

[Roth, Sönmez, and Ünver, *JET* 2005]

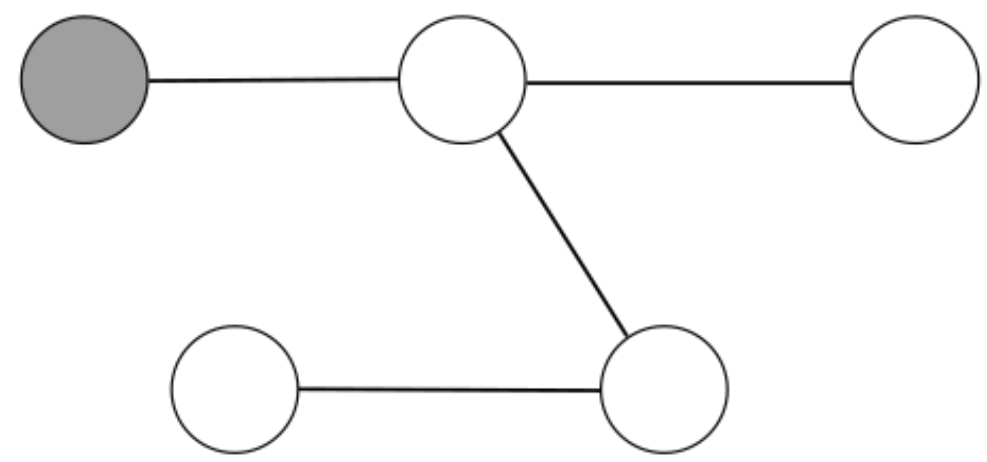

Given an undirected graph (of patient-donor pairs),
find **a** maximum cardinality matching.

underspecified (can lead to **incentive issues**)

Proposal 2: Kidney Exchange using Matchings

[Roth, Sönmez, and Ünver, *JET* 2005]

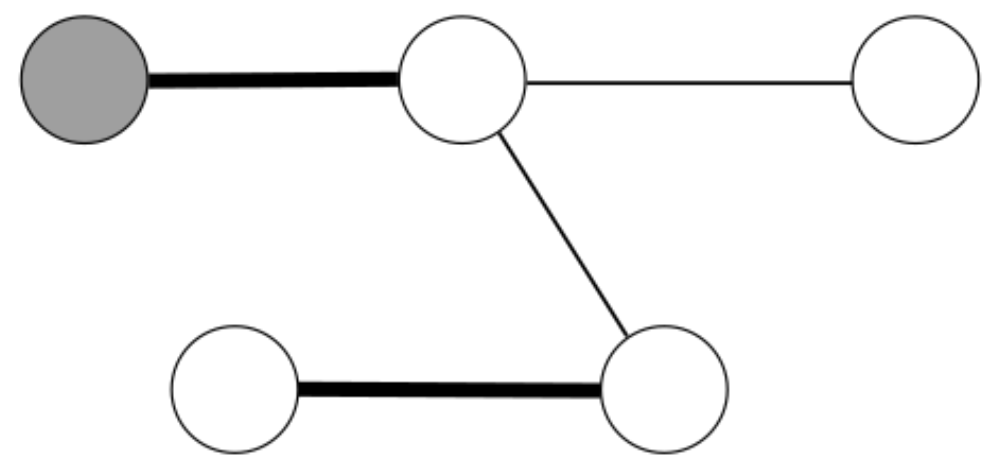

Given an undirected graph (of patient-donor pairs),
find **a** maximum cardinality matching.

underspecified (can lead to **incentive issues**)

Proposal 2: Kidney Exchange using Matchings

[Roth, Sönmez, and Ünver, *JET* 2005]

Proposal 2: Kidney Exchange using Matchings

[Roth, Sönmez, and Ünver, *JET* 2005]

Priority Mechanism



Proposal 2: Kidney Exchange using Matchings

[Roth, Sönmez, and Ünver, *JET* 2005]

Priority Mechanism

Consider a *priority ordering* $1, 2, \dots, n$ over vertices (can't be misreported).

Proposal 2: Kidney Exchange using Matchings

[Roth, Sönmez, and Ünver, *JET* 2005]

Priority Mechanism

Consider a *priority ordering* $1, 2, \dots, n$ over vertices (can't be misreported).
Let M_0 be the set of **maximum matchings** of the given graph.

Proposal 2: Kidney Exchange using Matchings

[Roth, Sönmez, and Ünver, *JET* 2005]

Priority Mechanism

Consider a *priority ordering* $1, 2, \dots, n$ over vertices (can't be misreported).

Let M_0 be the set of **maximum matchings** of the given graph.

For $i = 1, 2, \dots, n$:

Proposal 2: Kidney Exchange using Matchings

[Roth, Sönmez, and Ünver, *JET* 2005]

Priority Mechanism

Consider a *priority ordering* $1, 2, \dots, n$ over vertices (can't be misreported).

Let M_0 be the set of **maximum matchings** of the given graph.

For $i = 1, 2, \dots, n$:

Let S_i be the set of matchings in M_{i-1} that match **vertex i** .

Proposal 2: Kidney Exchange using Matchings

[Roth, Sönmez, and Ünver, *JET* 2005]

Priority Mechanism

Consider a *priority ordering* $1, 2, \dots, n$ over vertices (can't be misreported).

Let M_0 be the set of **maximum matchings** of the given graph.

For $i = 1, 2, \dots, n$:

Let S_i be the set of matchings in M_{i-1} that match **vertex i** .

If S_i is non-empty, then $M_i \leftarrow S_i$. Otherwise, $M_i \leftarrow M_{i-1}$.

Proposal 2: Kidney Exchange using Matchings

[Roth, Sönmez, and Ünver, *JET* 2005]

Priority Mechanism

Consider a *priority ordering* $1, 2, \dots, n$ over vertices (can't be misreported).

Let M_0 be the set of **maximum matchings** of the given graph.

For $i = 1, 2, \dots, n$:

Let S_i be the set of matchings in M_{i-1} that match **vertex i** .

If S_i is non-empty, then $M_i \leftarrow S_i$. Otherwise, $M_i \leftarrow M_{i-1}$.

return M_n

Advantages of Kidney Exchange using Matchings

Advantages of Kidney Exchange using Matchings



Each matching in M_n matches the same set of vertices.

Advantages of Kidney Exchange using Matchings



Each matching in M_n matches the same set of vertices.



No agent will "underreport" the set of its compatible edges.

Advantages of Kidney Exchange using Matchings



Each matching in M_n matches the same set of vertices.



No agent will "underreport" the set of its compatible edges.



The resulting matching is **Pareto optimal**
(no other matching can match a superset of the matched agents).

Advantages of Kidney Exchange using Matchings



Each matching in M_n matches the same set of vertices.



No agent will "underreport" the set of its compatible edges.



The resulting matching is **Pareto optimal**
(no other matching can match a superset of the matched agents).



Polynomial time
(uses Edmonds-Gallai decomposition from Graph Theory)

Limitations of Kidney Exchange using Matchings

Limitations of Kidney Exchange using Matchings



As kidney exchange has evolved, the game has shifted.

It is the **hospitals**, and not the individual patient-donor pairs, that have become the new "players".

Limitations of Kidney Exchange using Matchings



As kidney exchange has evolved, the game has shifted. It is the **hospitals**, and not the individual patient-donor pairs, that have become the new "players".

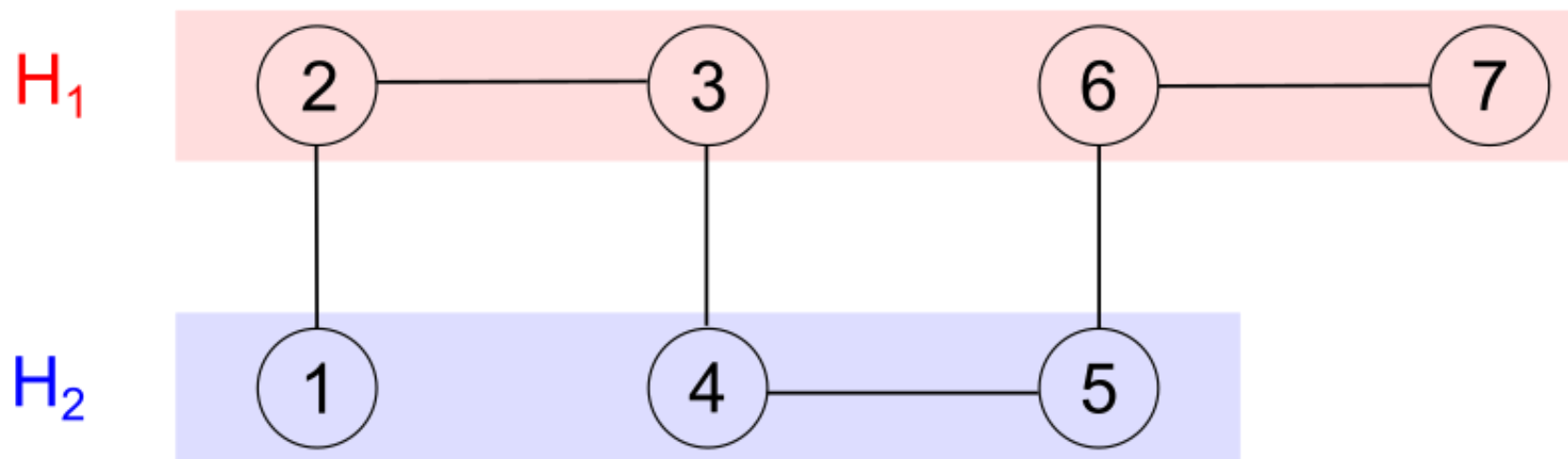

Limitations of Kidney Exchange using Matchings



As kidney exchange has evolved, the game has shifted. It is the **hospitals**, and not the individual patient-donor pairs, that have become the new "players".

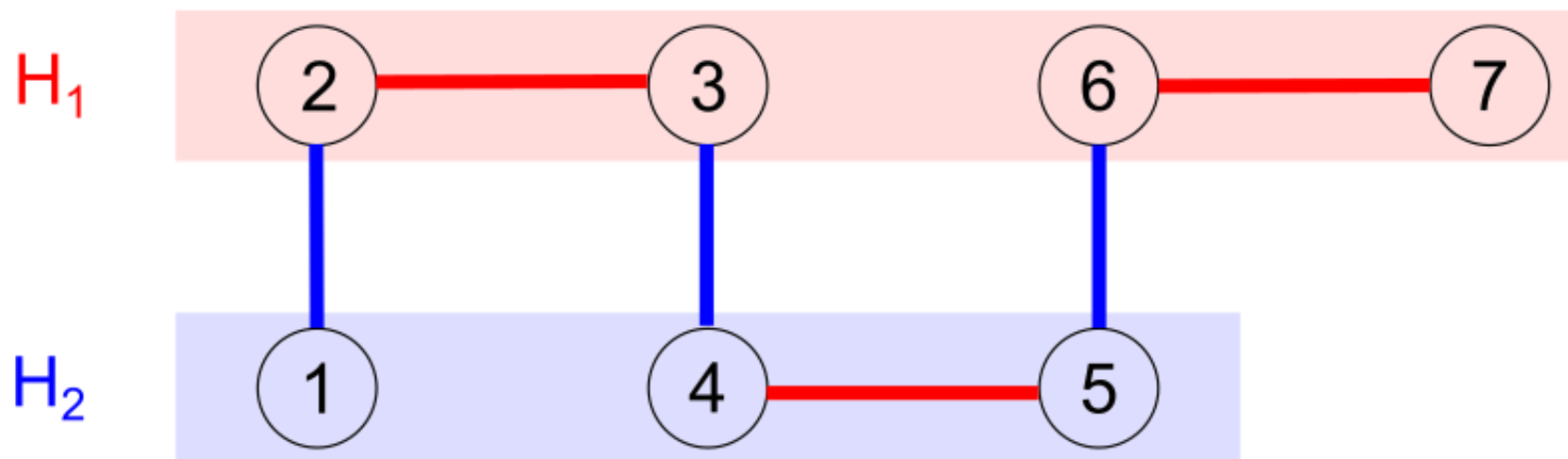

Limitations of Kidney Exchange using Matchings



As kidney exchange has evolved, the game has shifted. It is the **hospitals**, and not the individual patient-donor pairs, that have become the new "players".

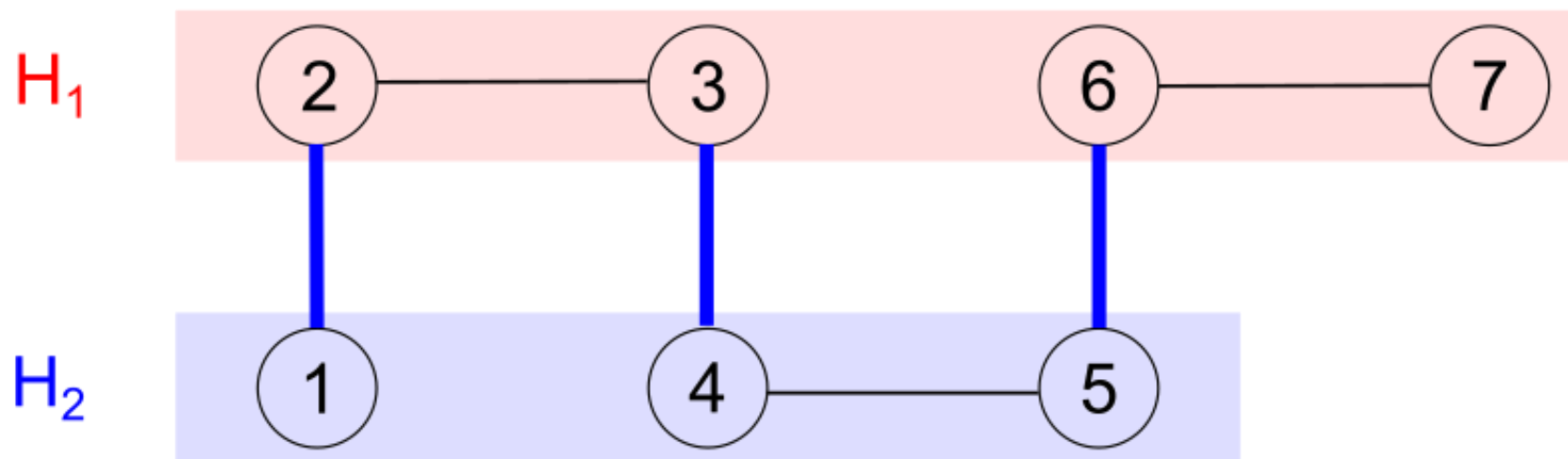

Limitations of Kidney Exchange using Matchings



As kidney exchange has evolved, the game has shifted. It is the **hospitals**, and not the individual patient-donor pairs, that have become the new "players".

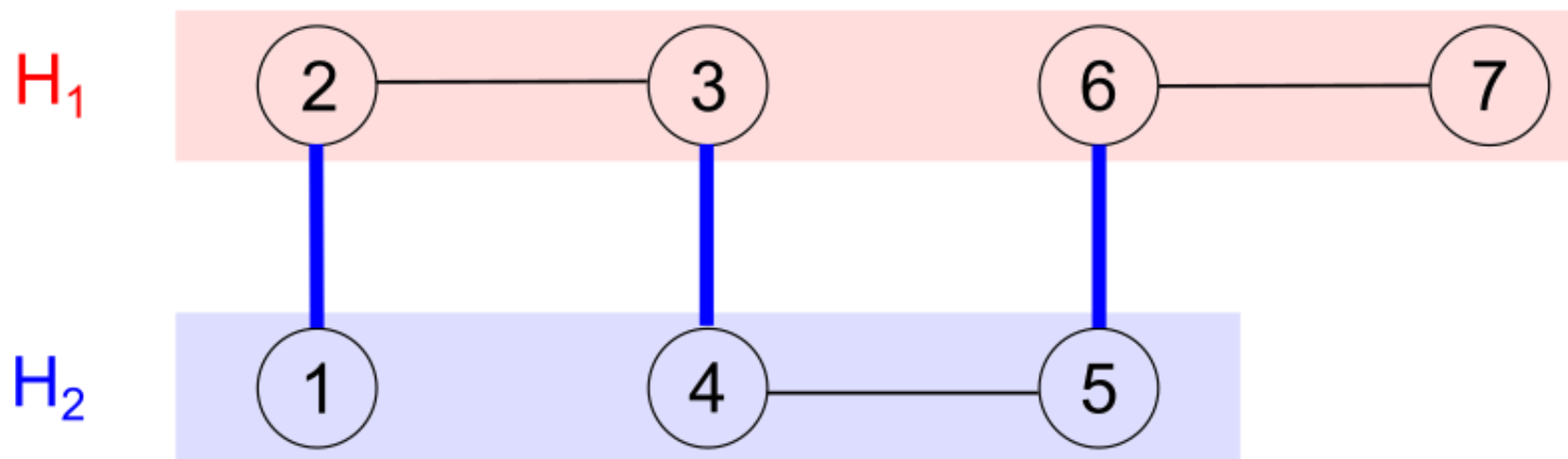

Hospital H_1 can match (2) and (3) internally (i.e., not disclose these pairs to the matching algorithm) and have all of its patients matched.

Limitations of Kidney Exchange using Matchings



As kidney exchange has evolved, the game has shifted. It is the **hospitals**, and not the individual patient-donor pairs, that have become the new "players".

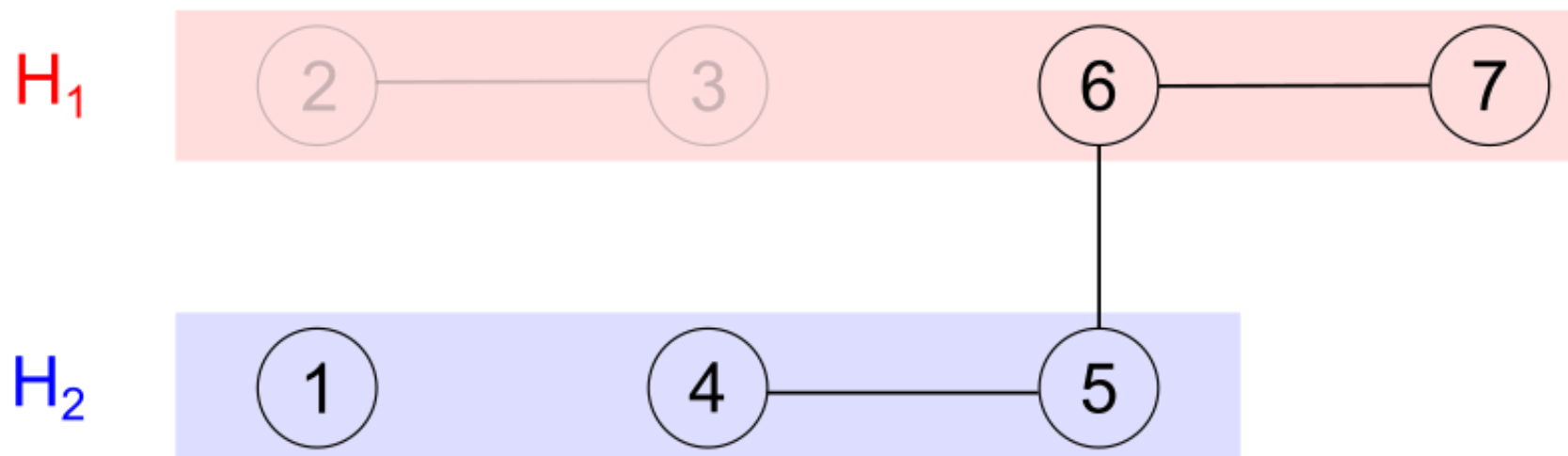

Hospital H_1 can match (2) and (3) internally (i.e., not disclose these pairs to the matching algorithm) and have all of its patients matched.

Limitations of Kidney Exchange using Matchings



As kidney exchange has evolved, the game has shifted. It is the **hospitals**, and not the individual patient-donor pairs, that have become the new "players".

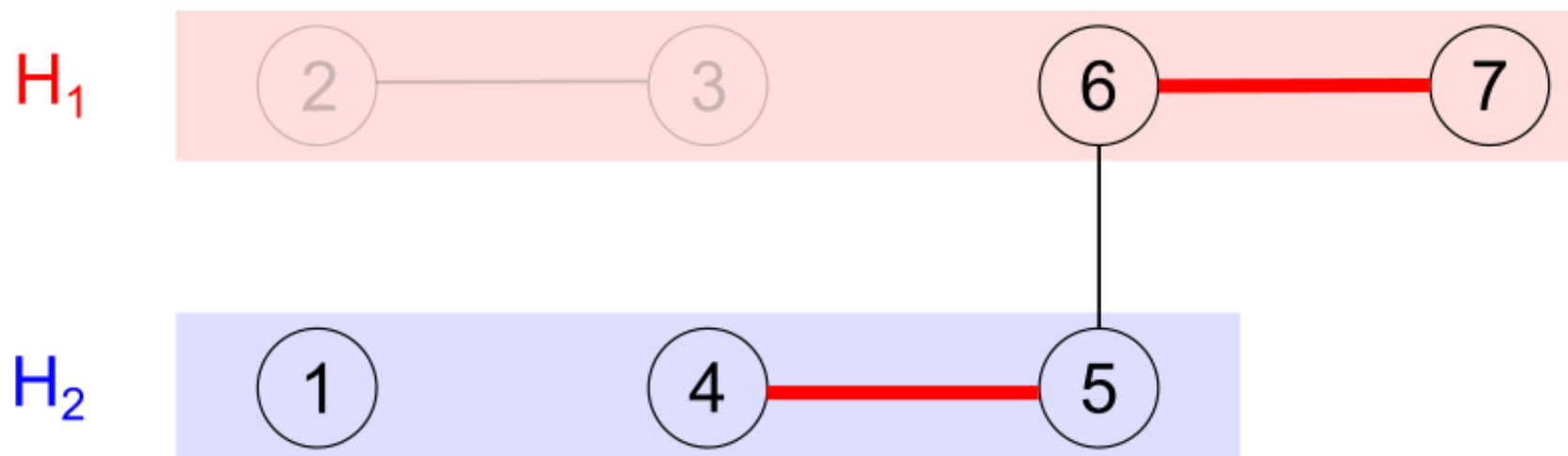

Hospital H_1 can match (2) and (3) internally (i.e., not disclose these pairs to the matching algorithm) and have all of its patients matched.

History [\[edit \]](#)

Year	Event
1986	KPD first suggested by Rapaport ^[14]
1991	First KPD program started in South Korea by Dr. Park ^[8]
1999	First European KPD transplants performed in Switzerland ^[8]
2000	First KPD transplants performed in USA at the Rhode Island Hospital ^[8]
2001	Hopkins completes KPD transplants and begins first KPD program in USA ^[15]
2004	Dutch established first national KPD program ^[8]
2007	NEAD chain started by APD utilizing first bridge donor ^[16]
2007	Charlie Norwood Living Organ Donation Act clarifies legality of KPD in USA ^[17]
2008	National Kidney Registry organizes its first transplants on Valentine's Day ^[18]
2009	Hopkins leads first 16 patient multicenter Domino Chain ^{[19][20]}
2010	UNOS organizes its first KPD transplants ^[8]
2012	National Kidney Registry completes largest chain involving 60 participants ^[6]
2014	National Kidney Registry sets new record with 70 participant chain ^[7]
2017	First Academic Paper published on "Chronological Incompatibility" outlining the ADP Voucher Program" ^[21]

History [\[edit \]](#)

Year	Event
1986	KPD first suggested by Rapaport ^[14]
1991	First KPD program started in South Korea by Dr. Park ^[8]
1999	First European KPD transplants performed in Switzerland ^[8]
2000	First KPD transplants performed in USA at the Rhode Island Hospital ^[8]
2001	Hopkins completes KPD transplants and begins first KPD program in USA ^[15]
2004	Dutch established first national KPD program ^[8]
2007	NEAD chain started by APD utilizing first bridge donor ^[16]
2007	Charlie Norwood Living Organ Donation Act clarifies legality of KPD in USA ^[17]
2008	National Kidney Registry organizes its first transplants on Valentine's Day ^[18]
2009	Hopkins leads first 16 patient multicenter Domino Chain ^{[19][20]}
2010	UNOS organizes its first KPD transplants ^[8]
2012	National Kidney Registry completes largest chain involving 60 participants ^[6]
2014	National Kidney Registry sets new record with 70 participant chain ^[7]
2017	First Academic Paper published on "Chronological Incompatibility" outlining the ADP Voucher Program" ^[21]

Altruistic Donors and Chains

Altruistic Donors and Chains

Donors who want to donate an organ without a designated recipient
(also known as a *non-directed* or *Good Samaritan* donor)

Altruistic Donors and Chains

Donors who want to donate an organ without a designated recipient
(also known as a *non-directed* or *Good Samaritan* donor)

waiting list



Altruistic Donors and Chains

Donors who want to donate an organ without a designated recipient
(also known as a *non-directed* or *Good Samaritan* donor)

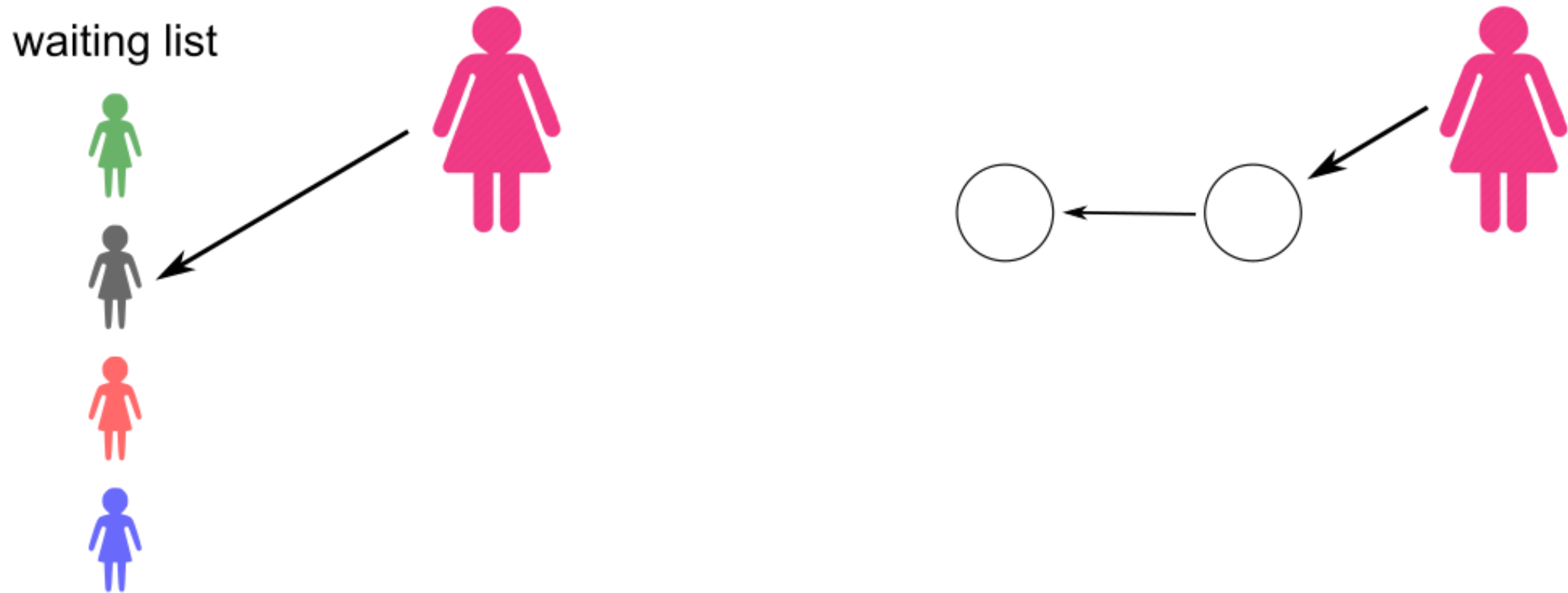

Altruistic Donors and Chains

Donors who want to donate an organ without a designated recipient
(also known as a *non-directed* or *Good Samaritan* donor)

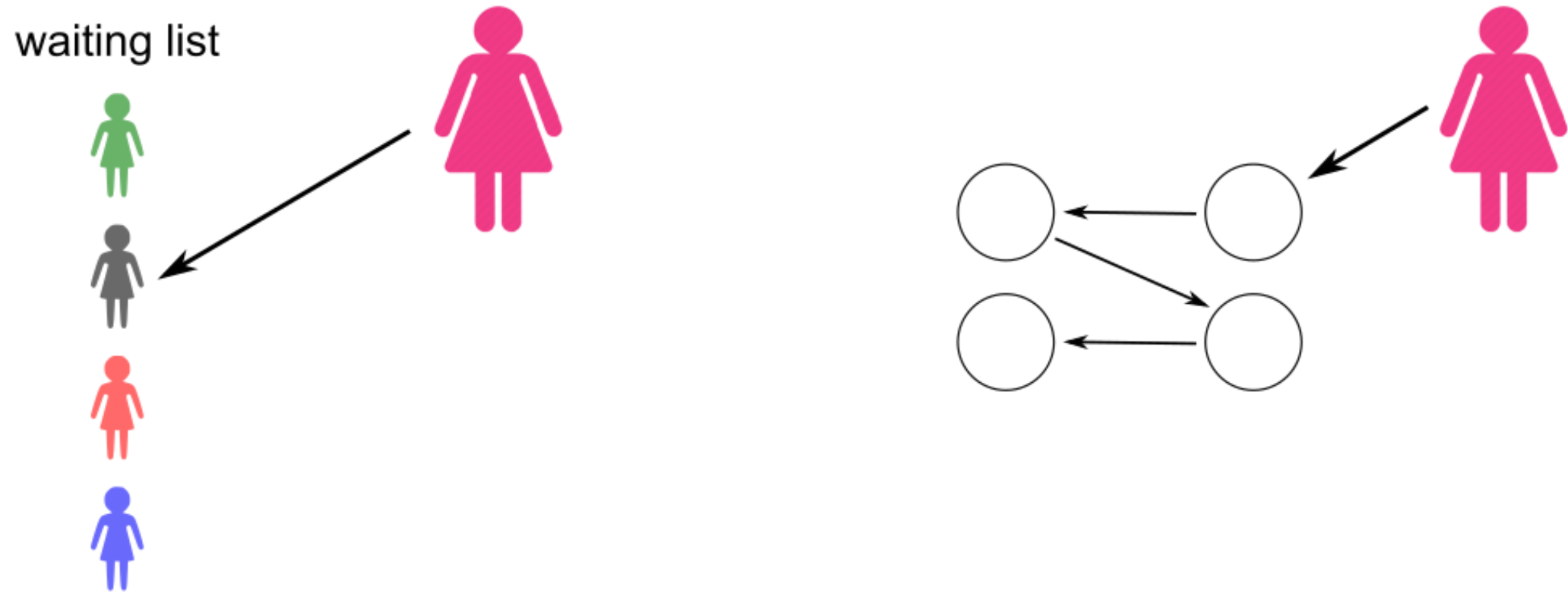

Altruistic Donors and Chains

Donors who want to donate an organ without a designated recipient
(also known as a *non-directed* or *Good Samaritan* donor)

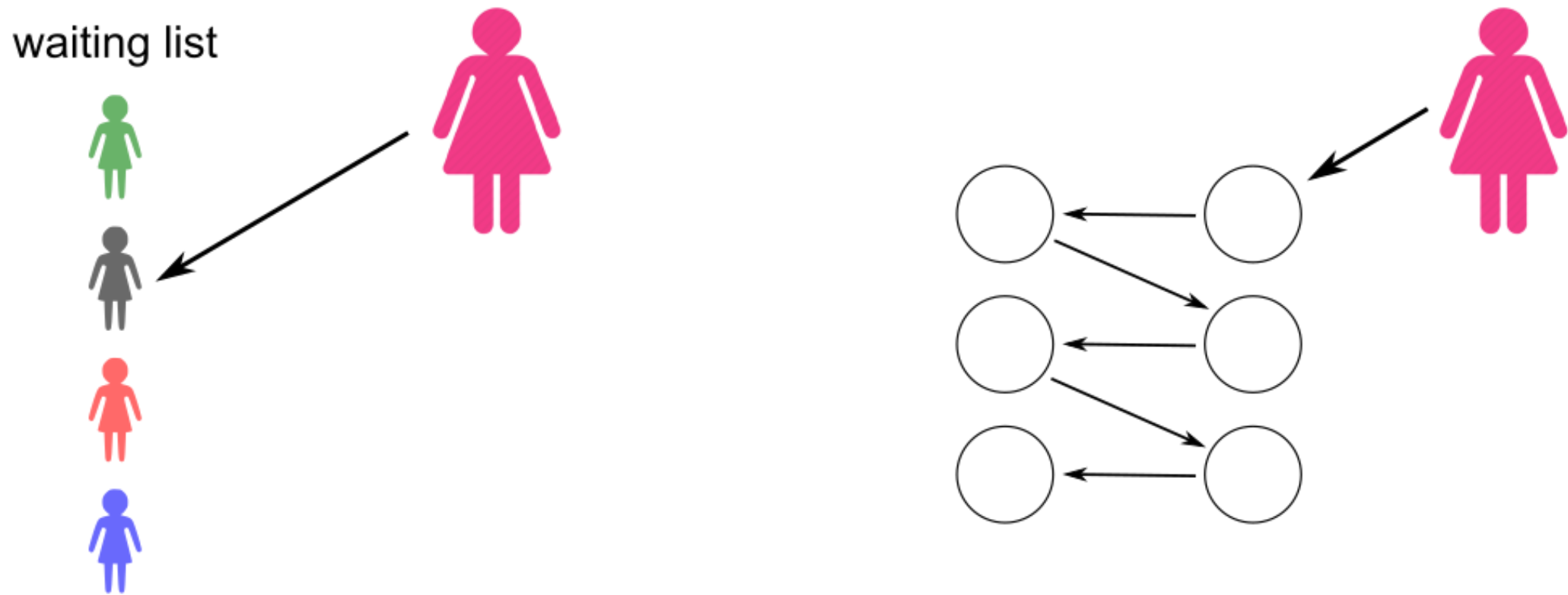

Altruistic Donors and Chains

Donors who want to donate an organ without a designated recipient
(also known as a *non-directed* or *Good Samaritan* donor)

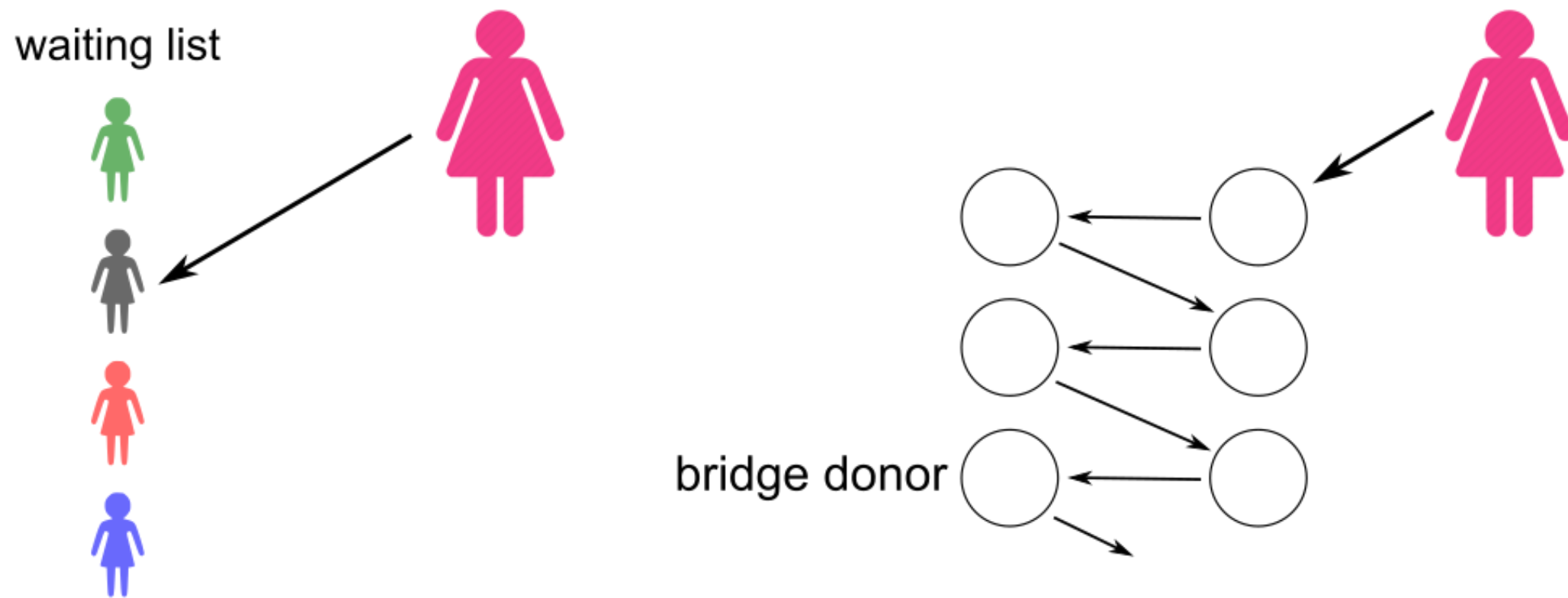

Altruistic Donors and Chains

Donors who want to donate an organ without a designated recipient
(also known as a *non-directed* or *Good Samaritan* donor)

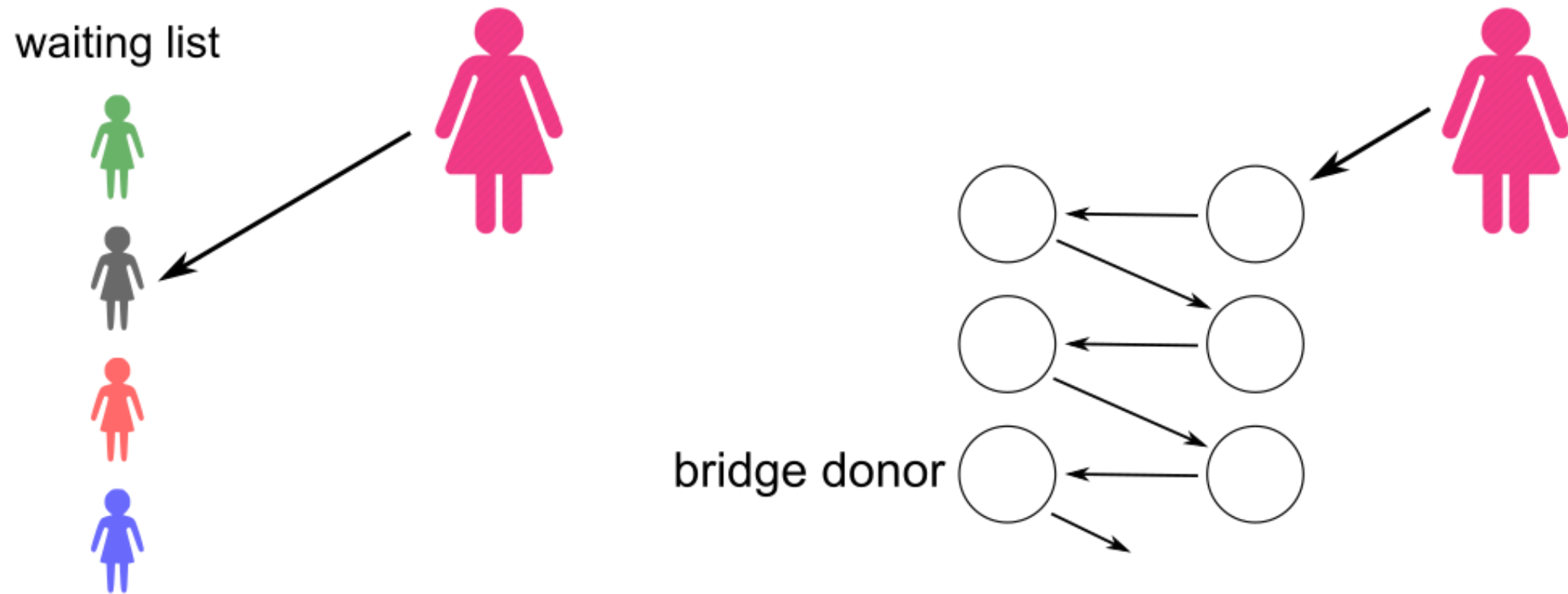

Transplants in an altruistic donor chain can be done **non-simultaneously**.

THE KIDNEY CHAIN

How a single organ donation changed 20 lives and created the longest-running transplant chain



MATT JONES, 30
Petoskey, Mich.
First donor

donated to



BARBARA BUNNELL, 56
Phoenix

married to



RON BUNNELL, 56
Phoenix

donated to



ANGELA HECKMAN, 34
Toledo, Ohio

daughter of



LAURIE SARVO, 54
Toledo, Ohio

donated to



REYNALDO ESPINOZA, 59
Germantown, Md.

donated to



CLAUDIA ALAS, 32
Germantown, Md.

daughter of



JEAN STAYLOR, 53
Charleston, S.C.

donated to



RAYMOND STAYLOR, 53
Charleston, S.C.

married to



AVA ROBY, 54
Marysville, Ohio

donated to



GEORGE LEONER, 51
Chillicothe, Ohio

brother of



LINDA JANISIESKI, 42
Miamisburg, Ohio

donated to



CECILIA JANISIESKI, 71
Huber Heights, Ohio

mother of



ANONYMOUS RECIPIENT

married to



ANONYMOUS DONOR

donated to



BILL CORAM, 55
Lincolnton, N.C.

friend of



TIM SHAIN, 43
Lincolnton, N.C.

donated to



LINLEY BLENKENSOPP, 51
Patchogue, N.Y.

brother of



KURT BLENKENSOPP, 41
Patchogue, N.Y.

donated to



KATHERINE MCKINNEY, 62
Toledo, Ohio

mother of



HELEENA MCKINNEY, 29
Cincinnati
Donor-in-waiting

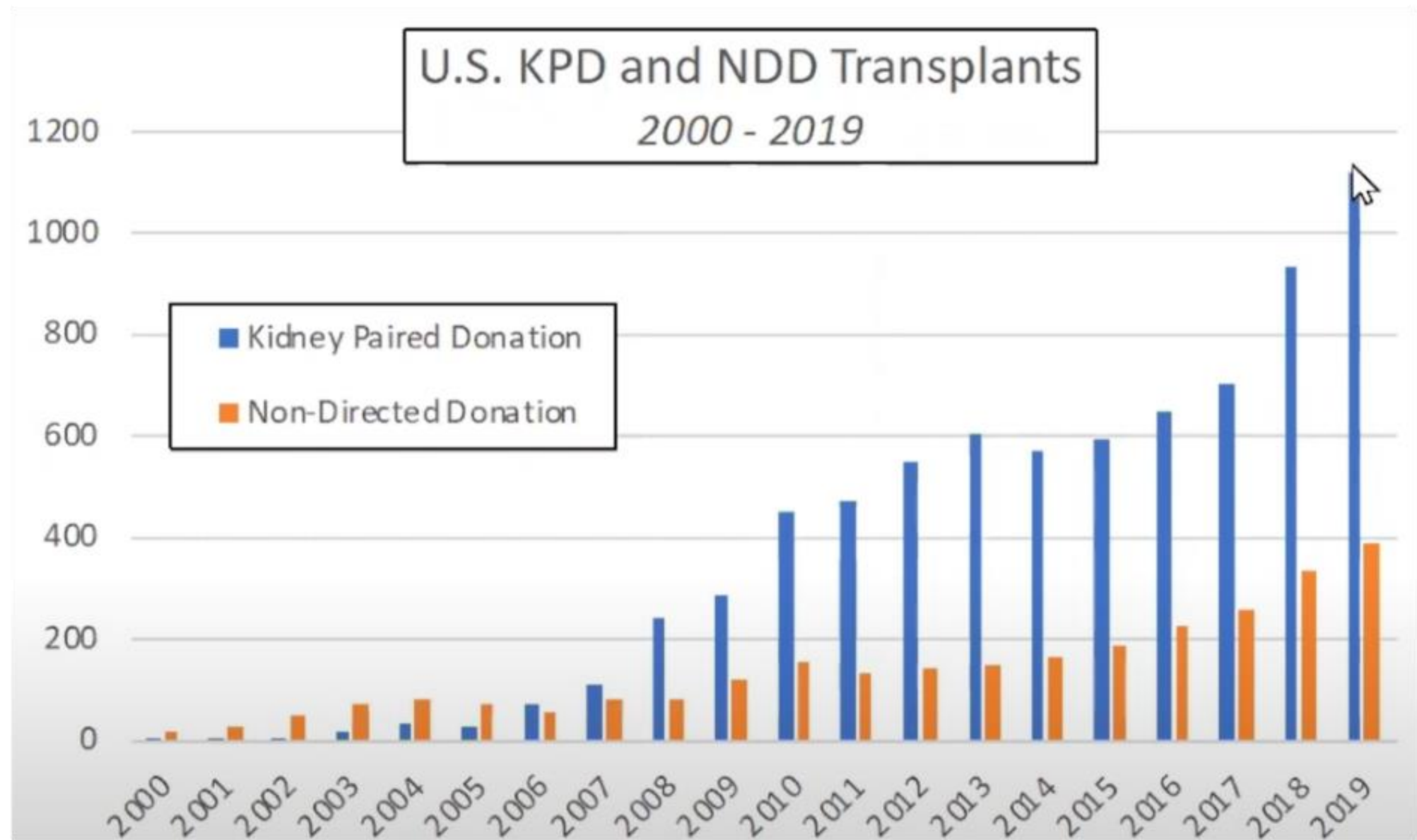

Figure source: Talk by Alvin Roth on "*Kidney Exchange: An Operations Perspective*" hosted by INFORMS Health Applications Society; June 2021

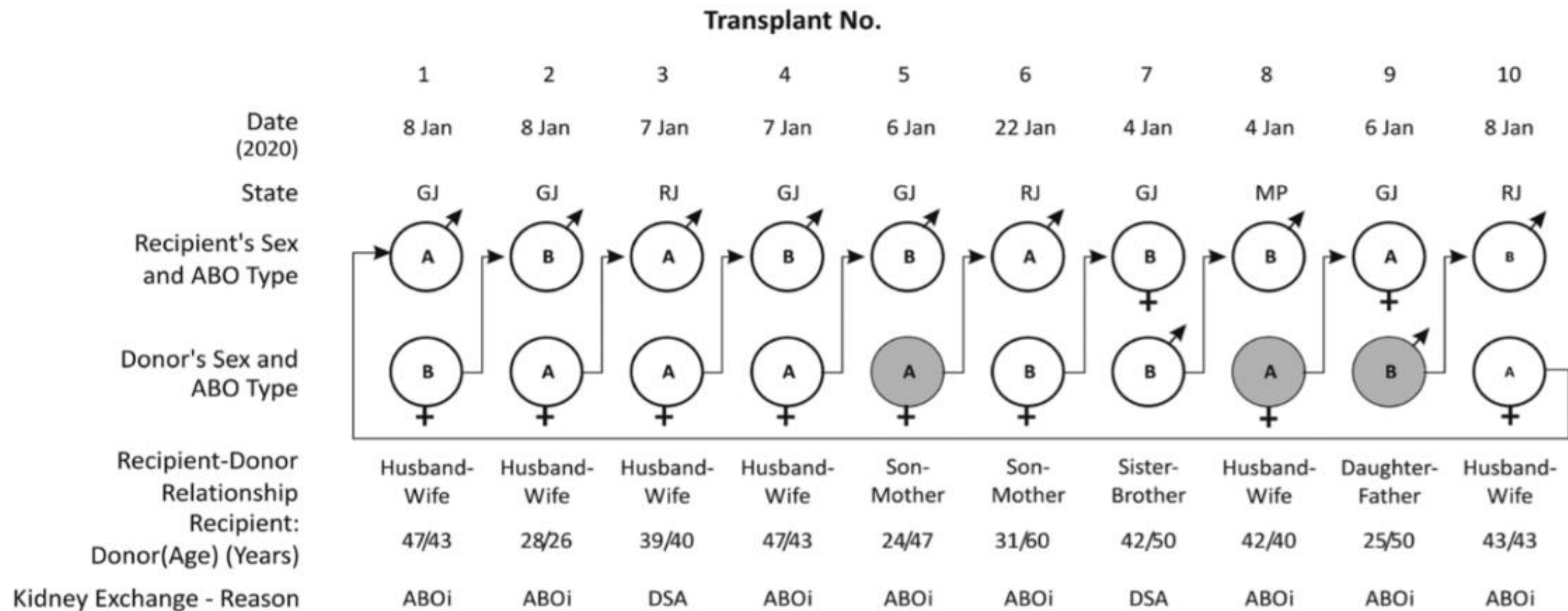
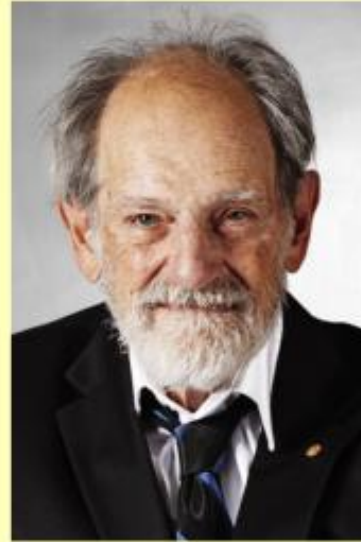

FIGURE 1. A nonsimultaneous 10-way kidney exchange cycle. GJ, Gujarat; MP, Madhya Pradesh; RJ, Rajasthan.

Sveriges Riksbank Prize in Economic Sciences in Memory of Alfred Nobel 2012



Alvin E. Roth



Lloyd S. Shapley

*"for the theory of stable allocations
and the practice of market design."*

Challenges in Kidney Exchange

Economic: Incentives of hospitals vs maximizing overall welfare.

Computational: Finding a maximum matching using 3-cycles is NP-hard.

Informational: Patients and donors arrive sequentially.

Logistical: Long cycles require many simultaneous surgeries.

Legal: Many countries do not permit altruistic donation.

Ethical: Is it OK to buy and sell kidneys?

Reminders

Assignment 1: Due Aug 21

Next Time

Cake cutting



Quiz

Quiz

Prove that TTCA outcome is Pareto optimal.

(An outcome A is **Pareto optimal** if there is *no other* outcome B such that everyone is at least as happy under B as they are under A and someone is strictly happier.)

References

- Housing markets and TTCA

Lloyd Shapley and Herbert Scarf

“On Cores and Indivisibility”

Journal of Mathematical Economics, 1(1), 1974 pg 23-37

<https://www.sciencedirect.com/science/article/pii/0304406874900330>

- Truthfulness under TTCA

Alvin E. Roth

“Incentive Compatibility in a Market with Indivisible Goods”

Economics Letters, 9(2), 1982, pg 127-132

<https://www.sciencedirect.com/science/article/pii/0165176582900039>

References

- The presentation is heavily inspired from Tim Roughgarden's lectures in the course on Algorithmic Game Theory (Fall 2013); see Lec 9 and 10.
<https://timroughgarden.org/f13/f13.html>
- Data about waiting list for organs in the US:
<https://optn.transplant.hrsa.gov/data/>
- Data about waiting list for kidneys in India (April 2019):
<https://www.narayanahealth.org/blog/kidney-transplants-in-india/>
- Wikipedia article on “Kidney Paired Donation”:
https://en.wikipedia.org/wiki/Kidney_paired_donation

References

- Proposal 1: Kidney exchange using top-trading cycles and chains

Alvin E. Roth, Tayfun Sönmez, and Utku Ünver
“Kidney Exchange”

The Quarterly Journal of Economics, 119(2), 2004 pg 457-488

<https://academic.oup.com/qje/article/119/2/457/1894508>

- Proposal 2: Kidney exchange using matchings

Alvin E. Roth, Tayfun Sönmez, and Utku Ünver
“Pairwise Kidney Exchange”

Journal of Economic Theory, 125(2), 2005 pg 151-188

<https://www.sciencedirect.com/science/article/pii/S0022053105001055>

References

- The “*You request my house, I get your turn*” extension of TTCA was originally proposed in the context of dormitory assignment:

Atila Abdulkadiroğlu and Tayfun Sönmez

“*House Allocation with Existing Tenants*”

Journal of Economic Theory, 88(2), 1999 pg 233-260

<https://www.sciencedirect.com/science/article/pii/S002205319992553X#>

- Altruistic donor chains:

Rees et al.

“*A Non-Simultaneous, Extended, Altruistic Donor Chain*”

The New England Journal of Medicine, 360(11), 2009 pg 1096-1101

<https://www.nejm.org/doi/full/10.1056/NEJMoa0803645>

References

- Videos, podcasts, and blogs:

<https://freakonomics.com/podcast/make-me-a-match/>
<https://www.donordiaries.com/>

https://www.youtube.com/watch?v=D3_0Bc7gbGA
<https://www.youtube.com/watch?v=exB1O3pTf7E>
<https://www.youtube.com/watch?v=4NbJTcfN6UA>
<https://www.donordiaries.com/episodes>

<http://marketdesigner.blogspot.com/search/label/kidney%20exchange>

